

# INSTRUCTION MANUAL



**LS SERIES - SINEWAVE INVERTER  
500W to 1800W**

Latronics P.O. Box 73 Moffat Beach Qld 4551  
Ph 61 7 5491 6988  
web: [www.latronics.com](http://www.latronics.com) email: [technical@latronics.com](mailto:technical@latronics.com)



REPLY PAID MB 1  
LATRONICS PTY LTD  
P. O. BOX 73  
MOFFAT BEACH QLD 4551

NO POSTAGE REQUIRED IF  
POSTED IN AUSTRALIA



# WELCOME

**Latronics** products are all proudly designed, engineered and manufactured in Australia. As a specialist Sine wave Inverter company we produce Inverters for a diverse range of applications such as; mining, railways, telecommunications, marine, remote power, motor homes, and other industrial or commercial installations.

In order to produce the most reliable products available, **Latronics** Inverters have been designed to endure the most rugged terrain and the harshest conditions across the Australian continent.

All products are engineered using the latest high quality components and manufactured to stringent quality standards, thus ensuring **Latronics** customers all enjoy many years of trouble free operation.

It is important to us at **Latronics**, that our clients enjoy the maximum benefits from our Inverters, in a safe and productive environment. Thus we strongly advise that you read through the next few pages of this manual, which explains all the modes of operation and relevant safety precautions for your new Power Inverter.

Please remember to complete and return your registration card on the last page of this manual to validate your 2-year warranty. Please retain your receipt as proof of purchase.

**LATRONICS**  
**PO BOX 73**  
**MOFFAT BEACH Q 4551**

**PH: 61 7 5491 6988      FAX: 61 7 5491 6792**

**EMAIL: [technical@latronics.com](mailto:technical@latronics.com)**  
**WEB: [www.latronics.com](http://www.latronics.com)**

## IMPORTANT !

Please complete and return this Registration Card to validate your 2-year Warranty

Serial No..... Date card returned.....



### REGISTRATION CARD

Your 2-year warranty is only valid if this card is completed & returned within 3 months of the date of purchase.

Name:.....Serial No:.....

Address: .....Post code:.....

Date of Purchase:.....Supplier:.....

Comments:.....

~Where is your Inverter being used?

Solar Power  Camping/Caravan  Marine/Boat  Commercial  Backup Supply  Other

~Was your decision made because of?

Features  Value for Money  Appearance  Recommendation  Warranty  Australian Made

~How do you rate the service from your supplier? Fair  Good  Very Good  Excellent

~Did your new Inverter meet your expectations? Above Expectations  Yes  No

## INVERTER SPECIFICATIONS

INVERTER MODEL	LS-512	LS-624	LS-648	LS-1012	LS-1224	LS-1248	LS-1512	LS-1824	LS-1848
Nominal DC Voltage	12V	24V	48V	12V	24V	48V	12V	24V	48V
Continuous Power	500W	600W	600W	1000W	1200W	1200W	1500W	1800W	1800W
1/2 Hour Rating	550W	750W	750W	1150W	1600W	1600W	1600W	2200W	2200W
Surge Rating (5 Secs)	1500W	2000W	2000W	3000W	3600W	3600W	4500W	5400W	5400W
Input Voltage Range	10.5-17V	21-34V	42-68V	10.5-17V	21-34V	42-68V	10.5-17V	21-34V	42-68V
Standby Current	27mA	22mA	19mA	37mA	28mA	22mA	42mA	30mA	24mA
Inverter ON-no load	0.42A	0.31A	0.15A	0.45A	0.25A	0.15A	0.67A	0.32A	0.18A
Peak Efficiency	90%	92%	93%	91%	92%	94%	91%	94%	94%
Weight	5.5Kg	5.5Kg	5.5Kg	11Kg	11Kg	11Kg	14Kg	14Kg	14Kg
Dimensions	260mm(L) x 160 mm(W) x 100 mm(H)								
Output Voltage	230Vac +/- 4%								
Output Frequency	50Hz +/- 0.1%								
Output Waveform	True Sinewave								
THD	< 4%								
Power Factor	All Conditions								
Autostart Sensitivity	0 - 20 W adjustable								
Operating Temperature	-10° C to +50° C								
DC to AC Isolation	3500 V								
Protection Circuitry	Overtemperature, Overload/Short Circuit, Battery Undervoltage/Overvoltage								
Battery Leads	1m with 10mm Lugs								
AC Output Wiring	Single Power Outlet 1.5m Long with 10mm Mounting Lugs								
Chassis	Powder Coated 2mm Aluminium Single Power Outlet & Junction Box Powder coated 3mm Aluminium								
Warranty	2 Years Parts and Labour								
Standards	As2279, AS3000, AS3100, EN55014, & C-TICK								
Ratings	Specifications @ 25° C ambient nominal battery voltage & unity power factor								

Due to constant improvements, specifications are subject to change without prior notice.

TABLE OF CONTENTS	PAGE
INSTALLATION	2
BATTERIES	4
DIP SWITCH SETTINGS	5
AUTO TRANSFER SWITCH	7
INVERTER OPERATION	8
EFFICIENCY & OUTPUT WAVEFORMS	10
AC WIRING & SAFETY	11
RADIO FREQUENCY INTERFERENCE	12
FAULT FINDING	14
WARRANTY CONDITIONS	15
INVERTER SPECIFICATIONS	16
REGISTRATION WARRANTY CARD	17



## **INSTALLATION**

- Ensure the Inverter has not been damaged in transit.
- The unit must be placed in a well-ventilated and protected area, not exposed to the open environment, and free from contaminants (i.e. Exhaust gases, sea air, battery gases, dust).
- A space of 10cm is needed on each side of the Inverter for adequate transfer of internal heat.
- The Inverter can be mounted vertically on a wall or horizontally on a table or shelf.

## **DC WIRING**

- For best performance, the unit should be placed as close as possible, but not directly on top of the battery supply.
- The Inverter DC input voltage is stated on the identification label of the Inverter. Check that it is the same voltage as the battery supply.
- The Inverter is designed to operate on a battery supply only.
- The Inverter is fitted with a circuit breaker in line with the battery positive lead, which negates the need for a battery fuse.
- Ensure the Inverter is switched OFF before connecting the DC supply. Turn the circuit breaker switch to the OFF position.
- Connect the Inverter DIRECTLY to the battery terminals for best performance.
- Input leads marked RED = (positive), & BLACK = (negative).

### **OBSERVE POLARITY**

**NOTE:** Cables connecting the Inverter to the battery are designed to achieve maximum efficiency and output power:

**DC CABLES SHOULD NOT BE EXTENDED**

## **WARRANTY CONDITIONS**

- All conditions and warranties expressed or implied by statute, common law, equity, trade, custom, usage, or otherwise howsoever are hereby expressly excluded to the maximum extent permitted by law. Where so permitted the liability of Latronics for a breach of condition or warranty that cannot be excluded is limited (at Latronics option) to the replacement or repair of the goods or of acquiring equivalent goods or the cost of replacing or repairing the goods or of acquiring equivalent goods. Latronics shall not be liable in any way whatsoever for indirect or consequential loss or damage whatsoever (whether based on tort or contract or otherwise).
- Damage caused by unauthorized repair, alteration or substitution of non-standard parts, incorrect installation, misuse, negligence, accident or similar cause, or usage other than in accordance with the operating instructions, is not covered under warranty.
- Unauthorized opening of the goods will render the Warranty invalid.
- The company may, at its discretion, agree to act as agent for the owner where delivery is requested and all costs for cartage and insurance will be for the owners account.
- The replacement of any part or labor involved will not have the effect of extending the period of the warranty of the goods.
- Any faulty part replaced under Warranty becomes the property of the Company for purpose of examination and claim under proprietary Warranty.
- Registration Card must be returned within 3 months from date of purchase to validate your 2-year warranty.
- Keep your receipt as proof of purchase, should any difficulties arise concerning the return of the registration card.
- Inverters are supplied by the manufacturer, or the manufactures agents, under the express condition that no responsibility is implied or accepted by the above parties for any damage to any appliance, equipment or property associated with the correct or otherwise operation of the Inverter.
- If service is required contact your local supplier/installer, or contact Latronics direct on Ph: 61 7 5491 6988. **Please ensure that you have the Inverter Model and Serial number available to enable prompt processing.**

## **FAULT FINDING**

Should the Inverter appear to be malfunctioning we suggest the following to eliminate any external problems:

1. Turn the Inverter "OFF" via the circuit breaker switch on the front panel.
2. Disconnect all AC wiring from the Inverter.
3. Disconnect DC battery leads from Battery. Clean all terminals by removing all grease/corrosion on both DC leads and battery terminals.
4. Ensure you have sufficient battery capacity at the nominal voltage (specified on the compliance label of your Inverter).

Please note: Use minimum 100AH battery or the size of a substantial car battery.

5. Make connection directly to battery terminals and ensure all connections are tight.
6. Ensure battery voltage is within the correct limits as outlined in the section INVERTER SPECIFICATIONS of this manual. If you do not have a DC voltmeter or multimeter check the front panel for Overvolts and Undervolts LED'S.
7. Turn the Inverter ON via the circuit breaker switch on the front panel. Observe the lights on the front left of your Inverter. Refer to INVERTER OPERATION sections for explanation of Indicator lights.
8. Plug in various appliances and monitor the Inverters operation.

## **HELPFUL HINTS**

- \* Remember that the Inverter automatically starts when a load is applied.
- \* Make sure leads and terminals are not corroded or faulty in any way.
- \* Make sure the Inverter goes into STANDBY with no load switched on.
- \* Make sure the circuit breaker is reset properly. If unsure switch OFF and ON again.

## **WIRING DIAGRAMS for 12, 24 & 48 Volts DC**

### 12-Volt System

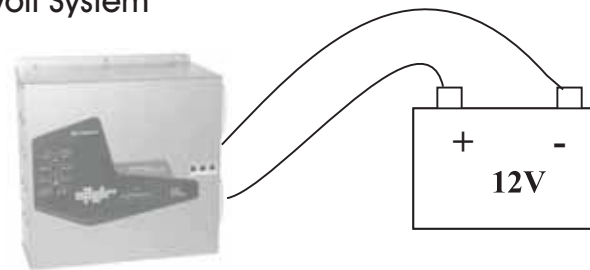

### 24-Volt System

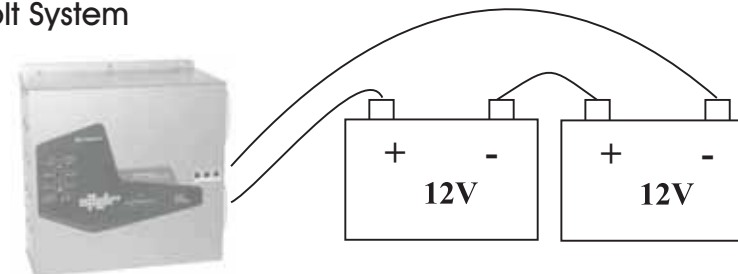

### 48-Volt System

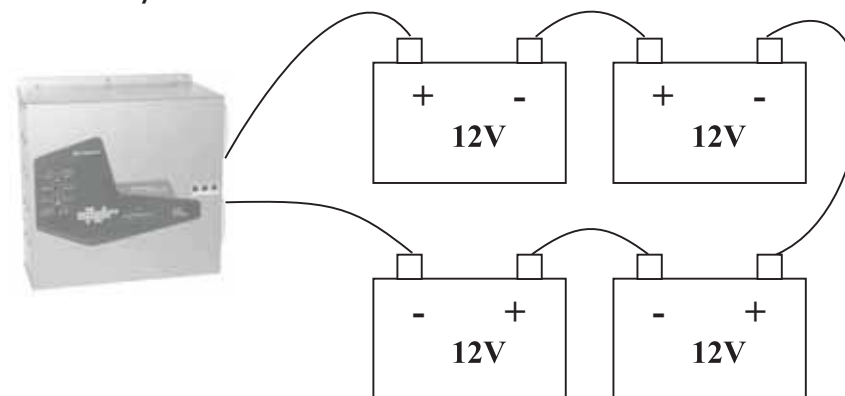

N.B. Ensure sufficient battery capacity to match load requirements!

## **BATTERIES**

### **BATTERY SIZING**

***It is important to match your battery size according to the power rating of the inverter.***

To ensure peak performance, it is important to choose the right battery for your Inverter. The battery size required will depend on the load and intended running time. Use this formula as a general guide:

Recommended Battery Size = Inverter rating in watts ÷ input voltage × 10

e.g. 1200W ÷ 12V × 10 = 1000Ah

Minimum Battery Size = Inverter rating in watts ÷ input voltage × 3

e.g. 1200W ÷ 12V × 3 = 300Ah

***Do not use an undersized battery as this may result in an Inverter that does not start or that will rapidly discharge the battery and may cause damage to the battery.***

### **MAINTENANCE**

Battery terminals require frequent care and maintenance. Very high current (up to several hundred amps), is drawn by the inverter when starting electrical motors and other high power appliances. We recommend an inspection of the batteries and the interconnecting cable connections once every 1-3 months or as recommended by the battery manufacturer.

1. Regularly check all connections; make sure they are always tight. Battery terminals are made of soft lead which will slowly compress over time eventually causing loose connections.
2. Check all connections are free of corrosion. Remove any corrosion and coat the terminals with Vaseline or grease to help prevent future corrosion.
3. Take specific gravity or SG readings of each cell using a hydrometer to check the level and performance of each battery. Alternatively a battery voltage reading for each cell will suffice but may not be accurate for multiple batteries connected in parallel. Report any serious imbalance to your system installer or battery supplier for corrective action.

### **SAFETY**

When working on batteries protective clothing and eye wear should be worn. Extreme care should be taken not to short circuit any battery terminals especially with tools. If in doubt have the work carried out by qualified personnel.

## **STATEMENT OF QUALITY ASSURANCE**

The whole of the supplies have been subjected to the Quality System Requirements in accordance with the conditions of AS/NZS ISO 9002: 1994.

All items are manufactured with full traceability. All LS Series True Sinewave Inverters conform to the C-Tick mark for the EMC emission standard EN55014.





## **RADIO FREQUENCY INTERFERENCE**

Radio Frequency Interference (RFI) is a phenomenon that exists in modern society and is a problem in many areas of electronics. For Inverter users, RFI normally presents itself in the form of static and/or interference when listening to an AM radio and in unusual cases may interfere with TV reception.

Over the years Latronics has continued to invest significant time and effort in the reduction of RFI related emissions from the entire product range, so that they comply with the appropriate International and/or Australian Standards.

Even with this compliance, there are situations where RFI may still be a cause for concern, and can differ greatly from installation to installation. Accordingly, the following is a list of recommendations made to assist in the overall reduction of RFI.

1. Separate DC and AC wiring. Avoid running DC and AC cables in the same conduits and/or cable trenches. It is strongly recommended that DC and AC wiring be separated by the greatest distance possible. In extreme cases, the use of shielded conduit may be necessary.
2. Minimize length of DC cabling. DC cables can act as an aerial, therefore all such cables should be kept as short as is practicable. For best performance minimize DC cable length to inverter and batteries and if possible avoid the use of auxiliary DC loads.
3. 240Vac Earth. For household installations, it is recommended that a "good" Earth Stake is located as nearby the Inverter as is possible.
4. AM and HF Radios. These types of radio equipment inherently suffer from all forms of RFI, especially when the received signal level is weak. In such cases reception can sometimes be improved by relocation of the radio itself, alternatively the use of an appropriate external antenna and co-axial cable may be necessary. External antennas should be located in a manner that ensures maximum signal strength whilst affording the greatest possible distance away from the Inverter and batteries.
5. Televisions. TV signals are transmitted as FM waveforms. This type of signal fundamentally reduces the effects of RFI, therefore the use of a good antenna and feeder cable is normally sufficient to ensure quality reception. Locating the television as far as possible from the Inverter may also improve picture clarity.
6. Mobile Installations. Due to the limitations of this type of installation, the best results for the minimization of RFI are usually obtained by maximizing the distance between the Inverter and the Radio/Television.

## **DIP SWITCH SETTINGS**

Dip Switch Settings apply to all models from 1000W to 1800W inclusive.

In order to access these options you have to open the Inverter. Before altering the settings switch Inverter OFF, adjust the setting and switch Inverter back ON again. We recommend these adjustments be carried out by qualified personnel or your system installer.

### **SW1 Hz 50/60 Hz**

ON = 50Hz (factory setting)      OFF = 60Hz

If you need to operate American or Japanese equipment this option will allow your Inverter to operate at 60Hz.

### **SW2 & SW3 SP Special**

### **SW4 AR Automatic Reset**

OFF = Disabled      ON = Enabled (factory setting)

This feature is designed to restart the Inverter and maintain power in the event of an external fault. Should the Inverter shut down due to under voltage, over temperature or any fault condition it will attempt to reset every 8 minutes until the fault condition clears and normal operation resumes. For overload shutdown the Inverter will only attempt 5 restarts. If the Inverter can not resume normal operation within 5 restarts, it will remain OFF until reset manually. This prevents continuous re-application of power to faulty appliances or wiring.

For under voltage shutdown the Inverter will restart when the battery voltage reaches the reconnect value as shown in the table below.

### **SW5 & SW6 UV Under Voltage Settings**

SW5 OFF & SW6 OFF = (factory setting)

Setting		12V Value		24V Value		48V Value	
SW5	SW6	Disconnect	Reconnect	Disconnect	Reconnect	Disconnect	Reconnect
ON	ON	10.0	12.0	20.0	24.0	40.0	48.0
OFF	OFF	10.5	12.5	21.0	25.0	42.0	50.0
ON	OFF	11.0	13.0	22.0	26.0	44.0	52.0
OFF	ON	11.5	13.5	23.0	27.0	46.0	54.0

## DIP SWITCH LOCATION

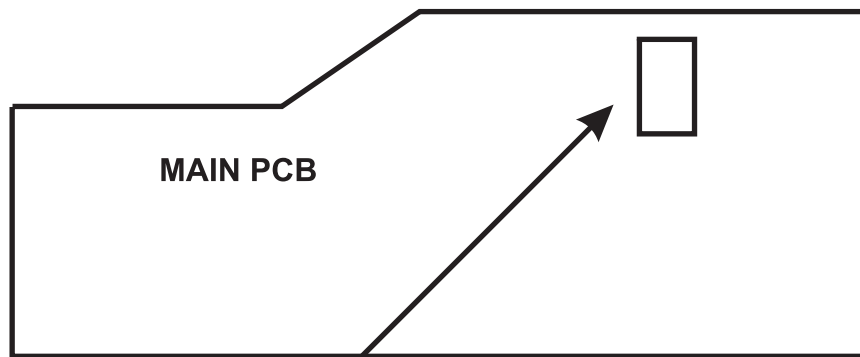

1  
2  
3  
4  
5  
6

DIP Switch located on Main PCB

OFF ON

### WARNING:

Due to dangerous voltages existing inside the unit, make sure the circuit breaker switch is turned off before opening the unit.

Should you have any doubt about performing these modifications, we strongly recommend the use of a qualified trades person.

## SAFETY

### Inverter Isolation and Safety

- \* All Latronics Inverters have an isolation rating of 3500V between AC and DC via the toroidal transformer, which ensures extremely safe and risk free operation.
- \* All the switching electronics and control circuitry are on the DC input.
- \* The single pole circuit breaker assembly ensures that when the Inverter is switched OFF, it is isolated from the battery supply.

*Please refer to relevant Australian Standards for safety procedures.*

### AC WIRING

- \* Make sure the Inverter is switched OFF before working on the mains wiring. Turn the circuit breaker switch into OFF position.
- \* The active and neutral of the AC output are electrically isolated from the battery negative, battery positive, and earth connections.
- \* The inverter AC output is connected directly to the Transformer output winding.
- \* Latronics Inverters have the AC output (active and neutral) floating with respect to the DC and Earth. The Earth connection is connected to the case only. This configuration provides the highest safety and most flexibility for installation wiring.

### **POSSIBLE CONFIGURATIONS:**

- \* Domestic wiring - neutral and earth connected (MEN wiring).
- \* Telecom wiring - battery positive connected to earth.
- \* Industrial and vehicle wiring - floating system.
- \* Other - battery negative connected to earth (if required).

Ensure that power will never be fed into the Inverter AC output junction box from the Mains or Generator. ***This would result in the destruction of the unit and will not be covered by warranty.***

### WARNING:

***The Inverter output is just as lethal as normal mains electricity, thus it is important that all AC wiring complies with the requirements of the relevant wiring standards, (AS 3000).***

***Any work carried out on AC/Mains wiring is to be performed by Qualified and Licensed personnel only.***



## INVERTER EFFICIENCY & OUTPUT WAVEFORM

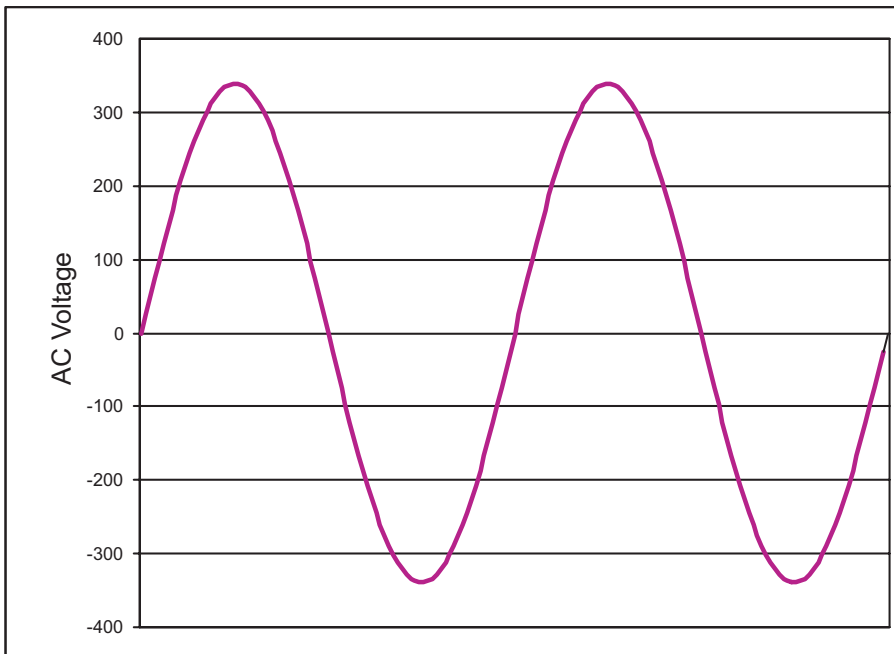
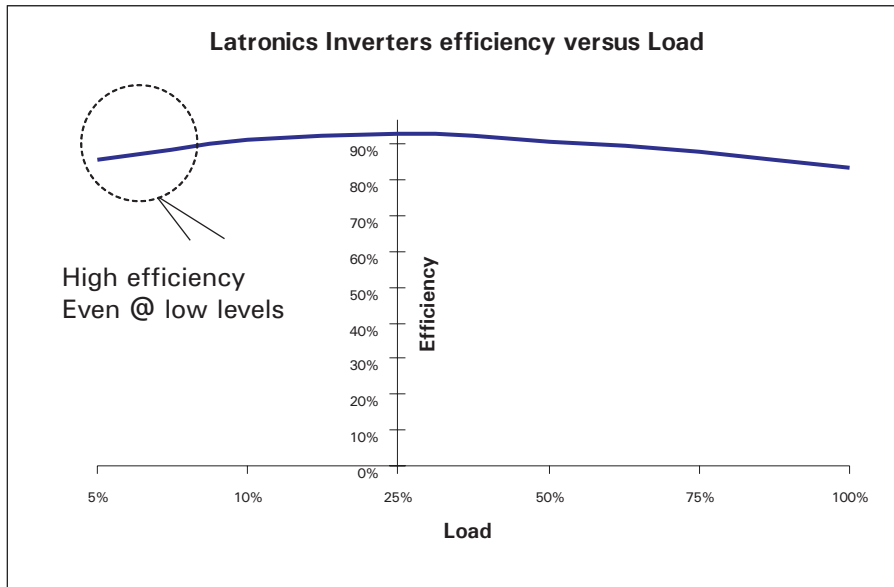

10

## AUTOMATIC AC TRANSFER SWITCH (Option)

Eliminate the need to manually switch your power source between inverter and generator. The transfer switch automatically senses generator AC power and switches the output between inverter and generator accordingly.

Take the hassle out of wiring a changeover switch between inverter and generator. Have this option fitted to your LS series inverter to simplify your power system wiring. Simply connect the generator to the hardwire terminals, its that easy!

### Features

- \* Available exclusively to the new LS series from 1000W to 1800W models
- \* No Break changeover time of 0.01 second (< half a cycle)
- \* Double pole contactor switching both active and neutral
- \* Minimise and simplify system wiring

### SYSTEM BLOCK DIAGRAM

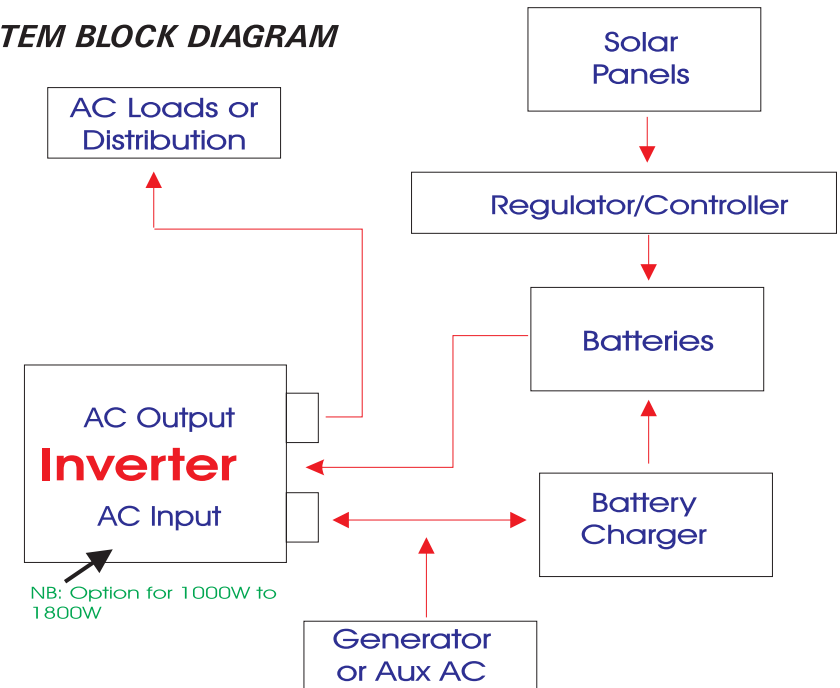

- \* Installation of system components and associated interconnecting wiring, should be performed by qualified and licensed personnel only.

7

## INVERTER OPERATION

When the Inverter is switched on all 3 LED'S light up for 1 second while the microprocessor performs a start up and system check procedure.

**Over temp./Over load (Red LED)**  
If the internal temperature exceeds safe operating limits of the components for more than five seconds, the Inverter will shut down in Over temp with this LED on continuously. Allow 5 minutes for the Inverter to cool and reset the unit. If the APPLIED load demands more current than the Inverter can safely supply for more than 5 seconds, the Inverter will shutdown in Over load and this LED will flash.

**Standby/240 volts (Green LED)**  
This LED flashes when in Standby mode (i.e. no loads connected). When a load is applied the LED will illuminate continuously to indicate that 240V AC is being supplied.

**Circuit Breaker ON/OFF Switch**  
The circuit breaker is designed for ease of operation and safety. By pushing the switch "UP", the battery supply is connected to the Inverter. The circuit breaker will turn OFF automatically if too large a load is left on the Inverter continuously. Reset the switch after allowing approximately 5 minutes to cool. If the Inverter shuts down due to Overload, Undervolts or Overvolts it can be reset by turning the circuit breaker OFF, waiting 10 seconds (or until LED goes out), then turning it on again.

**Undervolts/Overvolts (Red LED)**  
In order to protect the battery the Inverter will shutdown after 5 seconds if the battery voltage falls below its limit, (Undervolts), or exceeds the maximum, (Overvolts), as specified in the Electrical Specifications table. For Undervolts the LED will remain on continuous, while for an Overvolts situation the LED will continue to flash.

**Hardwire- 3 Terminal Output Junction Box**  
For distribution of AC output power.  
**1000W - 1800W Models only.**

**Battery leads**  
DC leads RED = battery positive, Black = battery negative.

**Power Outlet**  
Single unswitched socket

**AutoStart Sensitivity Adjustment**  
The screwdriver adjustment slot permits the operator to adjust sensitivity between 0- 20W. Due to lengthy AC cables the Inverter may sense fake loads. To combat this, turn the control clockwise. Alternatively turning the control in the opposite direction increases sensitivity. Turning the control fully anti-clockwise will disable the Auto Start feature and the Inverter will remain constantly ON.

**Fan**  
If the temperature inside the inverter reaches preset levels, the dual speed fan will switch on initially in low speed and then into high speed if the temperature continues to increase. Obstruction of the air intake and output will reduce the power rating of the Inverter.

**Hardwire-3 Terminal Input Junction Box**  
For connection of AC Input Power eg. from generator. (Available only when AC Transfer Switch option is fitted).  
**1000W - 1800W Models only.**

