

Xantrex™ XW System Control Panel

Owner's Guide

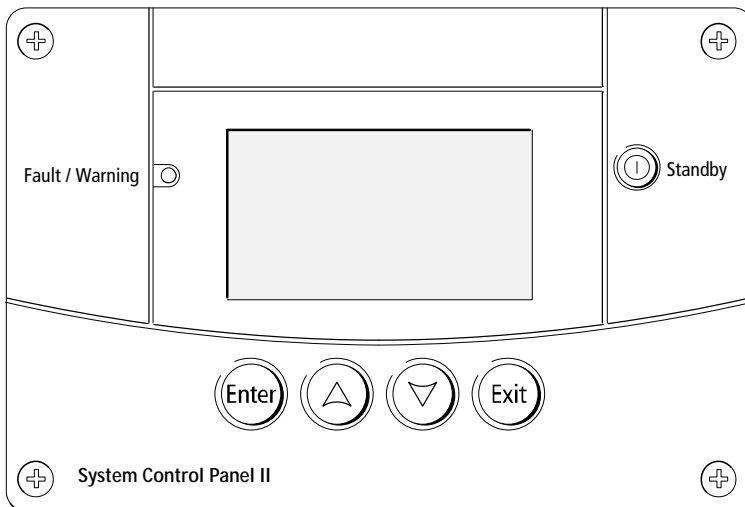

Xantrex XW System Control Panel

Owner's Guide

Trademarks

Schneider Electric, the **Schneider Electric logo**, **Xantrex**, and **Xanbus** are trademarks or registered trademarks of the Schneider Electric group of companies. Other trademarks, registered trademarks, and product names are the property of their respective owners and are used herein for identification purposes only.

Notice of Copyright

Copyright © 2007, 2008, 2009, 2010 Xantrex Technology Inc. All rights reserved. No part of this document may be reproduced in any form or disclosed to third parties without the express written consent of:

Xantrex Technology Inc.
161-G South Vasco Road
Livermore, California USA 94551

Xantrex Technology Inc. reserves the right to revise this document and to periodically make changes to the content hereof without obligation or organization of such revisions or changes unless required to do so by prior arrangement.

Exclusion for Documentation

UNLESS SPECIFICALLY AGREED TO IN WRITING, XANTREX TECHNOLOGY INC. ("XANTREX")

(A) MAKES NO WARRANTY AS TO THE ACCURACY, SUFFICIENCY OR SUITABILITY OF ANY TECHNICAL OR OTHER INFORMATION PROVIDED IN ITS MANUALS OR OTHER DOCUMENTATION;

(B) ASSUMES NO RESPONSIBILITY OR LIABILITY FOR LOSSES, DAMAGES, COSTS OR EXPENSES, WHETHER SPECIAL, DIRECT, INDIRECT, CONSEQUENTIAL OR INCIDENTAL, WHICH MIGHT ARISE OUT OF THE USE OF SUCH INFORMATION. THE USE OF ANY SUCH INFORMATION WILL BE ENTIRELY AT THE USER'S RISK; AND

(C) REMINDS YOU THAT IF THIS MANUAL IS IN ANY LANGUAGE OTHER THAN ENGLISH, ALTHOUGH STEPS HAVE BEEN TAKEN TO MAINTAIN THE ACCURACY OF THE TRANSLATION, THE ACCURACY CANNOT BE GUARANTEED. APPROVED XANTREX CONTENT IS CONTAINED WITH THE ENGLISH LANGUAGE VERSION WHICH IS POSTED AT WWW.SCHNEIDER-ELECTRIC.COM.

Date and Revision

March 2010 Revision D

Part Number





975-0298-01-01

Product Number

865-1050

Contact Information

www.schneider-electric.com

			
North America	1 650 351 8237 1 866 519 1470	1 925 245 1022	re.techsupport@schneider-electric.com
La France	+0825012999		fr-re.techsupport@fr.schneider-electric.com
Deutschland	+49 (0) 180 575 6575	+49 (0) 2102 404 7101	solarservice@de.schneider-electric.com
España	+34 93 498 7466	+34 93 305 5026	re.techsupport@es.schneider-electric.com
L'Italia	+39 035 4151111	+39 035415 3200	IT-pronto-contatto@it.schneider-electric.com

For other country details please contact your local Schneider Electric Sales Representative or visit our website at: <http://www.schneider-electric.com/sites/corporate/en/support/operations/local-operations/local-operations.page>

About This Guide

Purpose

The purpose of this Owner's Guide is to provide explanations and procedures for installing and operating the Schneider Electric Xantrex XW System Control Panel.

Scope

The Guide provides safety guidelines, setup information, and procedures for installing and configuring the Xantrex XW System Control Panel. This Guide also includes information about operating and troubleshooting the unit. This Guide does not contain guidelines for configuring every Xantrex Xanbus™-enabled device to which the Xantrex XW SCP connects. See the owner's guide or operation guide for each Xantrex Xanbus-enabled device for detailed configuration information.

Firmware Revision

Some Xantrex XW SCP features and functions described in this manual may be incompatible with later firmware revisions. To view the firmware revision number of your product, see "Viewing Device Information" on page 3-17.

Audience

The Guide is intended for anyone who needs to install and/or operate the Xantrex XW SCP. Installers should be certified technicians or electricians.

Organization

This Guide is organized into five chapters and one appendix.

Chapter 1, "Introduction", introduces and describes features of the Xantrex XW SCP.

Chapter 2, "Installation", contains information and procedures for installing the Xantrex XW SCP.

Chapter 3, "Configuration", contains information and procedures for configuring the Xantrex XW SCP and using the Xantrex XW SCP to configure another device.

Chapter 4, "Operation", contains information and procedures for operating the Xantrex XW SCP.

Chapter 5, "Troubleshooting", contains reference tables of warning and fault messages.

Appendix A, "Specifications", contains the electrical, mechanical, and environmental specifications for the Xantrex XW SCP.

Conventions Used

The following conventions are used in this guide.



WARNING

Warnings identify conditions or practices that could result in personal injury or loss of life



CAUTION

Cautions identify conditions or practices that could result in damage to the unit or other equipment.

Important: These notes contain information that is important for you to know, but is not as critical as a caution or warning.

Related Information

For more information about related products, refer to:

*Xantrex XW Series Hybrid Inverter/Charger Operation Guide
North America (975-0240-01-01)*

*Xantrex XW Series Hybrid Inverter/Charger Operation Guide Europe
(975-0385-01-01)*

*Xantrex XW Series Solar Charge Controller Owner's Manual
(975-0283-01-01)*

Xantrex XW Automatic Generator Start Owner's Guide (975-0307-01-01)

You can find more information about Schneider Electric as well as its products and services at www.schneider-electric.com.

Important Safety Instructions



WARNING: Save these instructions

This Owner's Guide contains important safety and operating instructions.

Before using your Xantrex XW System Control Panel, be sure to read, understand, and save these safety instructions.

General Precautions

1. Before installing and using this device, read all appropriate sections of this guide and any cautionary markings on the Xantrex XW SCP and the devices to which it connects.
2. If the Xantrex XW SCP has been damaged, see "Warranty and Return Information" on page WA-1.
3. Do not dismantle the Xantrex XW SCP; it contains no user-serviceable parts. See "Information About Your System" on page WA-4 for instructions on obtaining service.
4. Protect the Xantrex XW SCP from rain, snow, spray, and water.

Explosive Gas Precautions



WARNING: Explosion hazard

This equipment is not ignition protected. To prevent fire or explosion, do not install the Xantrex XW SCP in compartments containing flammable materials or in locations that require ignition-protected equipment. This includes any space containing gasoline-powered machinery, fuel tanks, as well as joints, fittings, or other connections between components of the fuel system.

FCC Information to the User

This equipment has been tested and found to comply with the limits for a Class B digital device, pursuant to part 15 of the FCC Rules. These limits are designed to provide reasonable protection against harmful interference when the equipment is operated in a residential environment. This equipment generates, uses and can radiate radio frequency energy and, if not installed and used in accordance with the instruction guide, may cause harmful interference to radio communications. However, there is no guarantee that interference will not occur in a particular installation. If this equipment does cause harmful interference to radio or television reception, which can be determined by turning the equipment off and on, the user is encouraged to try to correct the interference by one or more of the following measures:

- Reorient or relocate the receiving antenna.
- Increase the separation between the equipment and the receiver.
- Connect the equipment to a different circuit from that to which the receiver is connected.
- Consult the dealer or an experienced radio/TV technician for help.

CE Marking

This device is CE marked under the EMC Directive 2004/108/EC.

It complies with the following:

- EN61000-6-1:2007 Generic standards - Immunity for residential, commercial and light industrial environments
- EN61000-6-3:2007 Generic standards - Emissions for residential, commercial and light industrial environments

Contents

Important Safety Instructions - - - - -	vii
--	------------

1 Introduction

About the Xantrex XW System Control Panel - - - - -	1-2
Physical Features - - - - -	1-3
Front Panel Features - - - - -	1-3
Back Panel Features - - - - -	1-4
System Components - - - - -	1-4

2 Installation

Installing the Xantrex XW System Control Panel - - - - -	2-2
Materials and Tools Required - - - - -	2-2
Choosing a Location - - - - -	2-2
Network Installation - - - - -	2-3
Network Components - - - - -	2-3
Network Layout - - - - -	2-4
Guidelines for Routing the Xantrex Xanbus Cables - - - - -	2-5
Connecting Xantrex Xanbus Cables - - - - -	2-6
Mounting the Xantrex XW SCP - - - - -	2-7
Verifying the Installation - - - - -	2-11

3 Configuration

Configuration Using the Xantrex XW SCP - - - - -	3-2
Using Xantrex XW SCP Buttons - - - - -	3-2
Reading Screens and Menus - - - - -	3-2
Changing Settings for a Device - - - - -	3-6
Configuring the Xantrex XW System Control Panel - - - - -	3-8
Xantrex XW SCP Configuration Items - - - - -	3-9
Setting the Device Name - - - - -	3-10
Using the Clock Menu - - - - -	3-12
Clock Menu Configuration Items - - - - -	3-12
Setting the Time - - - - -	3-13
Setting the Date - - - - -	3-14
Using the System Settings Menu - - - - -	3-15
System Settings Menu Configuration Items - - - - -	3-15

Contents

Using Cascading Parameters-3-17
Viewing Device Information-3-17

4 Operation

System Modes 4-2
 Changing System Modes 4-2
 Operating Mode 4-2
 Standby Mode 4-2
 Using the Standby Button 4-3
Warnings and Faults 4-3
 Warning Messages 4-4
 Fault Messages 4-7

5 Troubleshooting

Troubleshooting Reference 5-2
 Types of Faults and Warnings 5-2
 Warning Reference Table 5-2
 Fault Reference Table 5-5

A Specifications

Electrical Specifications A-2
Mechanical Specifications A-2
Regulatory Compliance A-3
Environmental Specifications A-3

Warranty and Return Information-WA-1

Index IX-1

1

Introduction

Chapter 1 introduces and describes operational and physical features of the Xantrex XW System Control Panel.

About the Xantrex XW System Control Panel

Complete system control

The Xantrex XW System Control Panel provides configuration and monitoring capability for a Xantrex XW Power System.

The Xantrex XW SCP:

- Monitors activity throughout your power system
- Displays the settings and status of each Xantrex Xanbus-enabled device
- Enables you to adjust settings for each Xantrex Xanbus-enabled device.

System component

The Xantrex XW SCP uses Xantrex Xanbus, a network communications protocol developed by the manufacturer, to communicate its settings and activity to other Xantrex Xanbus-enabled devices.

Xantrex Xanbus-enabled products are:

- Easy to use. The Xantrex Xanbus network simplifies operation and automates routine tasks.
- Reliable. Software control eliminates errors due to analog signaling.
- Accurate. Digital information is less susceptible to interference and line loss.



Important: The Xantrex XW System Control Panel is compatible only with Xantrex XW System components, including Xantrex XW Hybrid Inverter/Chargers, Xantrex XW-MPPT Charge Controllers, and the Xantrex XW Automatic Generator Start.

System requirements

The Xantrex XW SCP requires a Xantrex Xanbus power supply to operate. Network power is carried by the network cables, and can be supplied by a Xantrex XW Hybrid Inverter/Charger.

As a device that draws network power, the Xantrex XW SCP consumes a maximum of 3 watts.

Operational Features

Other features of the Xantrex XW SCP include:

- Compatibility—connect additional Xantrex Xanbus-enabled Xantrex XW System devices without requiring additional device-specific control panels.
- Internal clock—keeps time for the entire system.
- Audible alarm—if enabled, alerts you when a fault condition arises.
- Low power consumption—automatically turns off the backlight after a period of inactivity.
- Non-volatile memory—preserves Xantrex XW SCP settings if network power is interrupted or network communication is disrupted.

Physical Features

See Figure 1-1 and Figure 1-2 for the front and back features of the Xantrex XW SCP.

Front Panel Features

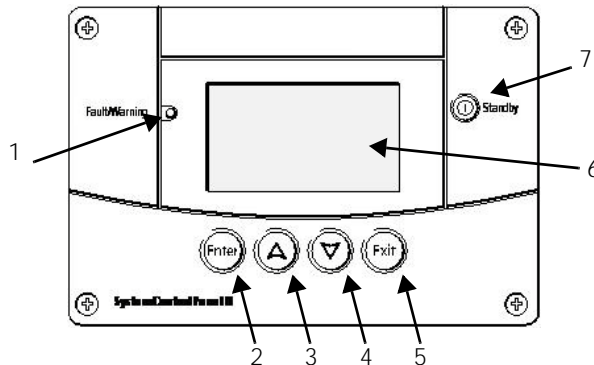

Figure 1-1 Front Panel

Feature	
1	Fault/Warning light indicates a device has a fault or warning condition and requires attention. The light flashes when a warning occurs, and turns on steadily when a fault occurs.
2	Enter button confirms selection of a menu item or displays the next screen.
3	Up arrow button scrolls upwards through screen text or increases a selected value.
4	Down arrow button scrolls downwards through screen text or decreases a selected value.
5	Exit button cancels selection of a menu item or displays the previous screen.
6	Screen shows menus, settings, and system information.
7	Standby button disables inverting and charging on all inverter/chargers in the system when pressed for one to two seconds. To enable inverting and charging, press the Standby button again. See "Using the Standby Button" on page 4-3.

Back Panel Features

Two Xantrex Xanbus network inputs on the back panel let you connect the Xantrex XW SCP to other Xantrex Xanbus-enabled devices. See Figure 1-2.

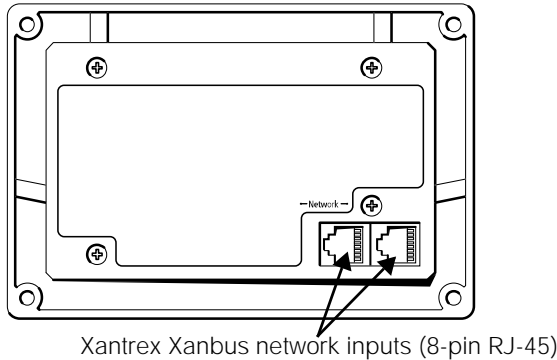

Figure 1-2 Back Panel

System Components

The Xantrex Xanbus system (Figure 1-3) includes the Xantrex XW SCP and other Xantrex Xanbus-enabled devices.

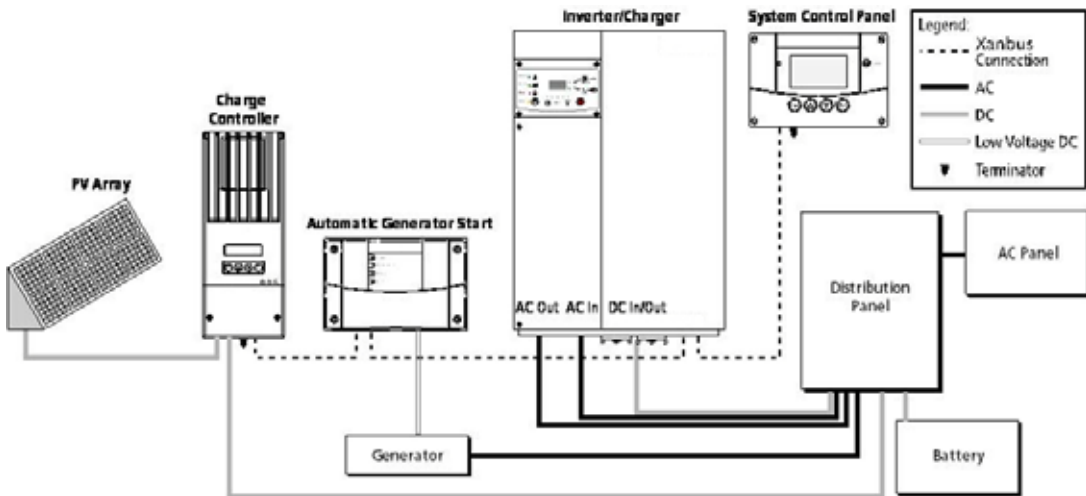

Figure 1-3 Xantrex Xanbus Network Diagram

2

Installation

Chapter 2 contains information and procedures for planning and performing a Xantrex XW System Control Panel installation, including:

- Materials and tools required
- Choosing a location
- Choosing a network layout
- Mounting the unit
- Connecting the Xantrex XW SCP to other devices.

Installing the Xantrex XW System Control Panel

The Xantrex XW System Control Panel is designed to be wall mounted (see page 2–7), and requires no connections other than Xantrex Xanbus network cables or a terminator plugged into the back of the unit.

Because you cannot access the Xantrex XW SCP network inputs once the unit is mounted, the Xantrex Xanbus cables must be routed through the wall and connected before securing the Xantrex XW SCP.

Materials and Tools Required

The following materials and tools are required to complete the installation:

- Mounting template sticker (supplied)
- Mounting plate (supplied)
- Mounting bracket (supplied)
- Four #6 screws (supplied)
- Two #8 screws (supplied)
- Cable clamps or hardware fasteners
- Xantrex Xanbus network cables or equivalent (CAT 5 or CAT 5e cable with RJ-45 connectors wired to T568A standard. One 2.1 meter cable is supplied)
- Two network terminators (one terminator is supplied with the Xantrex XW SCP and each Xantrex Xanbus-enabled device)
- Phillips head screwdriver
- Jigsaw or small keyhole saw
- Power drill with 1/8" bit (optional)

Choosing a Location

Choose a location that allows unobstructed access to the Xantrex XW SCP screen and buttons.

The location should be indoors, dry, and free from corrosive or explosive fumes.



WARNING: Explosion hazard

The Xantrex XW SCP is not Ignition Protected. Do not install in areas requiring Ignition-Protected equipment, such as areas containing gasoline engines, tanks, or fuel-line fittings.

Network Installation

This section describes requirements for installing the Xantrex XW SCP as part of a Xantrex Xanbus network-managed power system. For the system to function properly, requirements for network layout and termination must be followed.

Network Components

A Xantrex Xanbus network consists of the following components:

- Xantrex Xanbus-enabled devices—these include the Xantrex XW SCP, the Xantrex XW Series Inverter/Charger, Xantrex XW Automatic Generator Start (Xantrex XW AGS), and Xantrex XW Charge Controller. The network can consist of up to eight Xantrex Xanbus-enabled devices. A typical Xantrex XW Power System can include three inverter/chargers, two charge controllers, one Xantrex XW AGS and one Xantrex XW SCP.
- Xantrex Xanbus power supply—the network requires a power supply capable of providing 15 Vdc/200 mA to each device. The Xantrex XW Series Inverter/Charger provides network power, but if no inverter/charger is installed, an external power supply is required. Contact Schneider Electric for more information.
- Xantrex Xanbus cables—each Xantrex Xanbus-enabled device is connected by a standard straight-through Ethernet cable—CAT 5e. See Figure 2-1 on page 2–3. A 2.1 meter network cable is included with the Xantrex XW SCP. If more cables or a different length are required, these standard cables can be purchased from Schneider Electric or any computer supply store.



CAUTION: Equipment damage

Do not use crossover cable for the Xantrex Xanbus network cable. On crossover cable, the order of color-coded wires at each end of the cable is different.

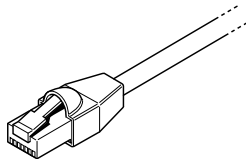

Figure 2-1 Xantrex Xanbus Cable

- Network terminators (Figure 2-2)—the Xantrex Xanbus network must be properly terminated at each end with network terminators. If the network is not properly terminated, signal quality is degraded and performance on the network is reduced. Permanent configuration without terminators is not supported by Schneider Electric. One terminator is included with the Xantrex XW SCP. Depending on your network layout, this terminator may need to be inserted into another device elsewhere in the network.

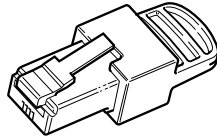

Figure 2-2 Xantrex Xanbus Network Terminators

Network Layout

Xantrex Xanbus-enabled devices are linked with separate lengths of Xantrex Xanbus cable, as shown in Figure 2-3.

To ensure communication signal quality, each end of the network must be terminated. The Xantrex Xanbus-enabled devices at each end of the network must have a male terminator inserted into their open network ports.

If the Xantrex XW SCP is the last device on the network, the open port on the Xantrex XW SCP must be terminated.

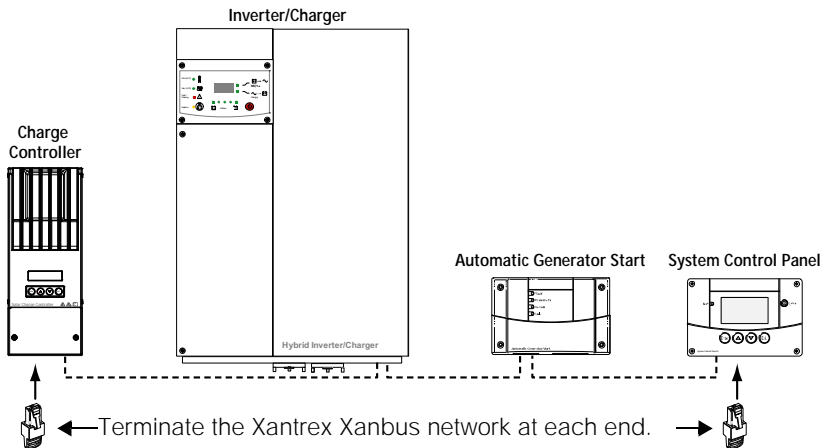

Figure 2-3 Daisy Chain Layout

Guidelines for Routing the Xantrex Xanbus Cables



WARNING: Shock hazard

Do not route the Xantrex Xanbus cables in the same conduit or panel as the AC and DC power cabling.

To ensure maximum performance of your network, follow these guidelines when routing the Xantrex Xanbus cables. Route the cables before installing the Xantrex XW SCP.

- Route the cables away from sharp edges that might damage the insulation. Avoid sharp bends in the cable—no less than a 100 mm radius.
- Allow at least 57 mm of space behind the wall to accommodate the depth of the unit and allow room for the cables to bend.
- Allow for some slack in the cable tension.
- Keep the alignment of wire pairs inside the sheath as straight as possible.
- Allow separation between data and power cables (data cables should only cross a power cable at right angles).
- Do not staple the cable with metal cable staples. Use appropriate hardware fasteners to avoid damage to the cable.

The total length of the network, including all connected Xantrex Xanbus-enabled devices and the Xantrex XW SCP, cannot exceed 40 m. Xantrex Xanbus cables are available in lengths from 0.9 m to 22.9 m.

Connecting Xantrex Xanbus Cables

Follow these guidelines for connecting Xantrex Xanbus cables to the Xantrex XW SCP. The cables are connected to the Xantrex XW SCP at the same time the Xantrex XW SCP is mounted. Read "Mounting the Xantrex XW SCP" on page 2-7 before performing the following procedures.



CAUTION: Equipment damage

Connect the Xantrex XW SCP only to other Xantrex Xanbus-enabled devices.

Although the cabling and connectors used in this network system are the same as Ethernet connectors, **this network is not an Ethernet system.** Equipment damage may result from connecting a Xantrex Xanbus system directly to a personal computer.



CAUTION: Unpredictable device behavior

Do not connect one end of the network to the other to make a ring or loop.

To connect Xantrex Xanbus cables to the Xantrex XW SCP:

1. Connect the Xantrex Xanbus cable (or two Xantrex Xanbus cables, if the Xantrex XW SCP is located between two Xantrex Xanbus-enabled devices) to a Xantrex Xanbus network input in the Xantrex XW SCP.
2. Route and connect the cable(s) to the nearest Xantrex Xanbus-enabled device(s).
3. For additional devices, continue connecting cable as described above.
4. Ensure the factory-supplied male network terminators are inserted into the empty inputs in the Xantrex Xanbus-enabled devices at the beginning and end of the network. When the network is completely connected, there should be no empty network inputs in any Xantrex Xanbus-enabled device.

Mounting the Xantrex XW SCP

The Xantrex XW SCP can be mounted three ways:

- Flush mounted through an opening in a wall using the mounting plate
- Surface mounted using the mounting bracket
- Flush mounted through an opening in a wall and secured with four #6 screws.



WARNING: Shock hazard

Before making an opening in a wall or panel, ensure there is no wiring or other obstruction within the wall.



CAUTION: Equipment damage

Provide adequate space within the wall for the Xantrex Xanbus cables to bend. Do not bend the cable to one side after it leaves the Xantrex Xanbus port. The mounting bracket itself does not provide enough space for the cables to bend. Attempting to route the cables through the side of the mounting bracket without providing space for the cables within the wall may damage to the Xantrex XW SCP Xantrex Xanbus ports and cause network communication problems.

To flush mount the Xantrex XW SCP with mounting plate:

1. Using a jigsaw and the supplied template sticker as a guide, cut out the hole for the mounting plate. The mounting plate fastens to walls up to 19 mm thick.
2. Route the Xantrex Xanbus cable(s) inside the wall and through the opening.

3. Insert the mounting plate with the two tabs in a vertical position into the hole (see Figure 2-4).

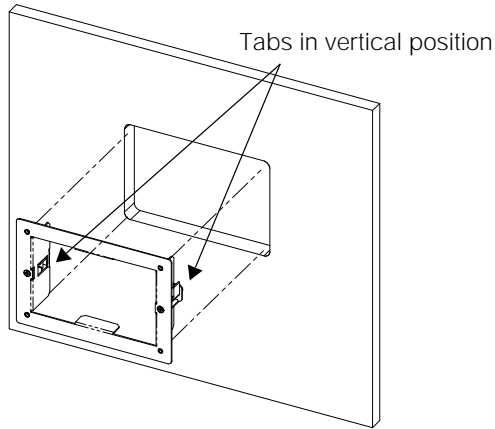

Figure 2-4 Inserting the Mounting Plate

4. Secure the mounting plate by tightening the two screws to rotate the tabs to the horizontal position (see Figure 2-5) and pull the tabs tight against the inner surface of the wall. Be careful not to overtighten the screws and damage the wall.

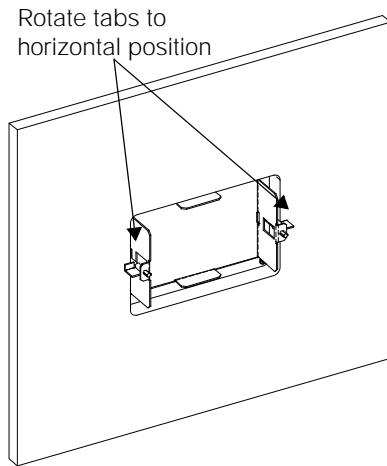

Figure 2-5 Securing the Mounting Plate

5. Connect the Xantrex Xanbus cable(s) (and terminator if necessary) to either network input on the back of the Xantrex XW SCP. See Figure 2-6.

Connect a network terminator to the Xantrex XW SCP if it is the last device at the end of a daisy chain network layout.

Important: To ensure communication signal quality, the network must be terminated at each end with a terminator.

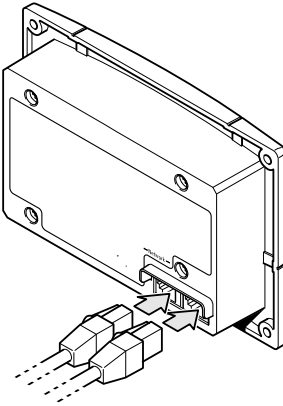

Figure 2-6 Connecting the Network Cables

6. Place the unit into the mounting plate and secure it with four #6 screws.

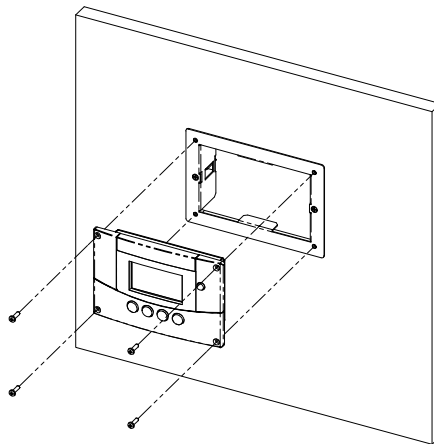

Figure 2-7 Securing the Xantrex XW SCP

7. Peel off the protective plastic coating covering the screen and indicator light.

To flush mount the Xantrex XW SCP with no mounting plate:

1. Peel the backing from the supplied mounting template sticker and place it in your chosen installation location. Use the template to mark the location for the area to be cut out.
2. Pilot-drill the mounting holes (if necessary, depending on your mounting surface) and, using a jigsaw, cut out the hole in which the Xantrex XW SCP will be inserted.
3. Route the Xantrex Xanbus cable(s) from other Xantrex Xanbus-enabled devices inside the wall and through the opening.
4. Connect the Xantrex Xanbus cable(s) (and terminator if necessary) to either network input on the back of the Xantrex XW SCP. See Figure 2-6.

Connect a network terminator to the Xantrex XW SCP if it is the last device at the end of a daisy chain network layout.

5. Place the unit in the opening and secure it with four #6 screws.
6. Peel off the protective plastic coating covering the screen and indicator light.

To surface mount the Xantrex XW SCP:

1. Using the supplied template sticker as a guide, mark the locations for two mounting screws and the access hole for the Xantrex Xanbus cables.
2. Using a hole saw, cut out the access hole for the Xantrex Xanbus cable(s).
3. Route the Xantrex Xanbus cable(s) from other Xantrex Xanbus-enabled devices inside the wall and through the access hole.
4. Attach the mounting bracket with two #6 screws.
5. Connect the Xantrex Xanbus cable(s) (and terminator if necessary) to either network input on the back of the Xantrex XW SCP.

Connect a network terminator to the Xantrex XW SCP if it is the last device at the end of a daisy chain network layout.

Important: To ensure communication signal quality, the network must be terminated at each end with a terminator.

6. Place the unit into the mounting bracket and secure it with four #6 screws. See Figure 2-8.
7. Peel off the protective plastic coating covering the screen and indicator light.

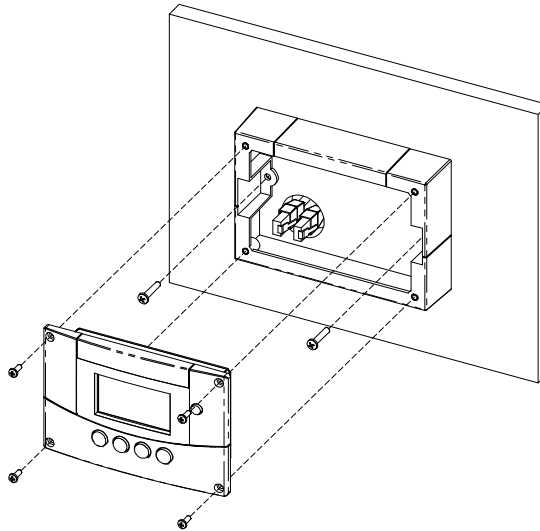

Figure 2-8 Surface Mounting the Xantrex XW SCP

Verifying the Installation

If network power (from an inverter/charger or external power supply) is present, the LCD backlight comes on and the Xantrex XW SCP shows the startup screen (see page 3-3).

When the Xantrex XW SCP is started up on the Xantrex Xanbus system for the first time, it displays a fault message asking you to set the clock before proceeding. For procedures for setting the clock, see “Setting the Time” on page 3-13 and “Setting the Date” on page 3-14.

3

Configuration

Chapter 3 contains guidelines for configuring the Xantrex XW System Control Panel and for using the Xantrex XW System Control Panel to configure other Xantrex Xanbus-enabled devices.

This chapter does not recommend specific settings for devices on your system. For device configuration information, refer to the Owner's Guide or Operation Guide for each Xantrex Xanbus-enabled device.

Configuration Using the Xantrex XW SCP

The Xantrex XW SCP can display and change the settings for any Xantrex Xanbus-enabled device in the Xantrex Xanbus system.

Using Xantrex XW SCP Buttons

The Xantrex XW SCP has four buttons for:

- moving between status screens and menus
- highlighting settings you want to change
- selecting and changing configurable values for Xantrex Xanbus-enabled devices.

See Table 3-1 for the function of each button on the Xantrex XW SCP.

Table 3-1 Xantrex XW SCP Buttons

Button	Function
Enter	<ul style="list-style-type: none"> • Displays the next screen • Confirms selection of a menu item
Up arrow	<ul style="list-style-type: none"> • Displays the previous Device Home screen • Scrolls up one line of text • Increases a selected value
Down arrow	<ul style="list-style-type: none"> • Displays the next Device Home screen • Scrolls down one line of text • Decreases a selected value
Exit	<ul style="list-style-type: none"> • Cancels selection of a menu item • Displays the previous screen

Reading Screens and Menus

The content of Xantrex XW System Control Panel screens and menus varies depending on power system activity or the device you have selected to view information for.

Viewing the Xantrex XW System Control Panel Home Screens

The top level screens on the Xantrex XW System Control Panel are the Startup screen, the System Status screen and the Device Home screens. After power is applied and the Startup screen appears, the Xantrex XW SCP displays the System Status screen. The Device Home screens can be viewed by pressing the up and down arrow buttons, as shown in Figure 3-1.

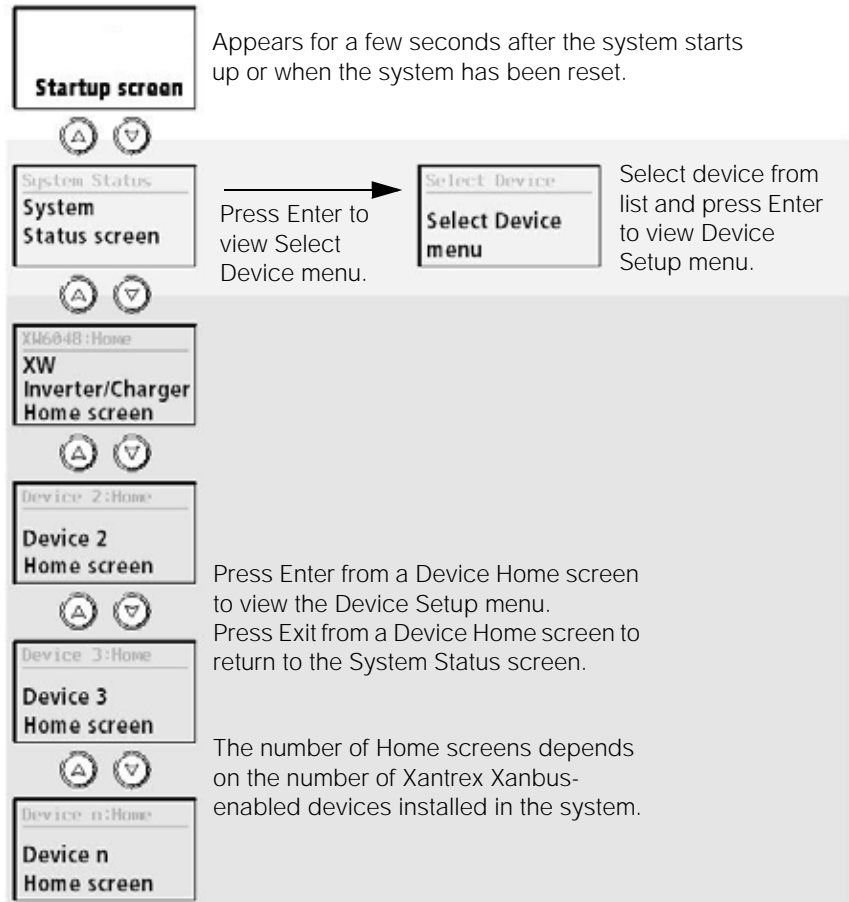

Figure 3-1 Xantrex XW System Control Panel Home Screens

System Status Screen

The System Status screen appears after the Startup screen. The System Status screen displays aggregated status information for the entire power system. A single system may have up to three Xantrex Xanbus network-connected Xantrex XW Inverter/Chargers, up to two Xantrex XW Solar Charge Controllers, one Xantrex XW Automatic Generator Start module and one Xantrex XW System Control Panel all connected to a single battery bank, a single generator and a common utility grid.

The System Status screen always features a "Menu" arrow pointing to the Enter button. Pressing Enter displays the Select Device menu.

Important: If you are uncertain which Xantrex XW System Control Panel screen or menu you are viewing, you can always return to the starting point—the System Status screen—by pressing Exit until the System Status screen appears.

Xantrex XW Inverter/Charger Home Screen

The Xantrex XW Inverter/Charger Home screen is the first of the Device Home screens. Each device installed in the system (except the Xantrex XW SCP) has its own Home screen. To view additional Device Home screens from the Xantrex XW Inverter/Charger Home screen, press the down arrow button.

The Xantrex XW Inverter/Charger Home screen displays status information for the Xantrex XW Inverter/Charger. The screen appearance varies with the status of the inverter/charger (Standby, Inverting, Charging, AC Bypass, Search, or Equalize). For more information, see the *Xantrex XW Series Hybrid Inverter/Charger Operation Guide*.

To display the Xantrex XW Inverter/Charger Home screen:

- ◆ From the System Status screen, press the down arrow key.

Viewing Other Screens

This section describes the next level of screens and menus on the Xantrex XW System Control Panel.

Select Device Menu

The Select Device menu displays a list of Xantrex Xanbus-enabled devices in the system, including the Xantrex XW Inverter/Charger and the Xantrex XW System Control Panel (Xantrex XW SCP).

The Select Device menu is where you can access the Setup menus for each device in the system. The length of the Select Device menu depends on how many Xantrex Xanbus-enabled devices are installed.

The Select Device menu also contains the Clock menu (where the time and date are set) and the System Settings menu (where system-level settings can be configured). The System Settings, Xantrex XW SCP, and Clock menus are always available from the Select Device menu, regardless of the number of Xantrex Xanbus-enabled devices installed.

To display the Select Device menu:

- ◆ From the System Status screen, press Enter.

Device Setup Menus

Device Setup menus display status information and changeable settings. Changeable settings are identified by the square brackets [] around values in the right-hand column.

To display the Setup menu for a device:

- ◆ On the Select Device menu, highlight the device name and press Enter.

-Or-

From the Device Home screen, press Enter.

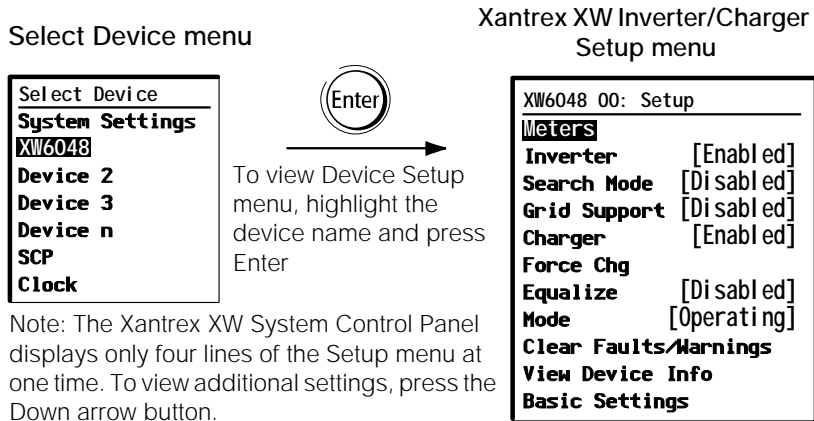

Figure 3-2 Selecting a Device Setup Menu

Changing Settings for a Device

You can view and change device settings from the device setup menu.

Basic menu

Each Device Setup menu can be displayed in Basic and Advanced formats. The Basic menu contains configuration items you may have to adjust routinely, or as part of initial setup.

Advanced menu

The Advanced menu gives you access to the full set of configuration menus for that device, including everything displayed on the Basic menu. As a safeguard against unintended advanced configuration, the Xantrex XW SCP displays the Basic menu by default. To view the Advanced menu, you must perform a special keypress.



WARNING: Risk of fire and shock hazard

The Advanced settings for devices other than the Xantrex XW SCP are intended for qualified installation/service personnel only. Before changing advanced settings, you must be familiar with the settings and the system-wide impact of changing those settings. Setting parameters incorrectly could damage connected equipment (such as batteries) or could severely affect the performance of your system. Incorrect charging configuration can lead to battery damage and risk of fire. Consult the local utility before enabling sell mode or changing sell mode settings.

To view the Advanced menu:

- ◆ On the Device Setup menu, press Enter + up arrow + down arrow at the same time.

Note: This keypress displays Advanced menus for every device in the system.

Identifying changeable settings

A Device Setup menu displays changeable settings and commands to view other menus. Changeable settings are enclosed in square brackets.

To select and adjust a setting:

1. On the Device Setup menu, press the up arrow or down arrow button to highlight the setting you want to change.

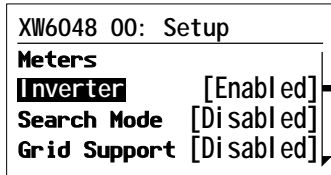

Basic menu shown.

2. Press Enter to highlight the current value of that changeable setting. The previously set value appears with an asterisk (*) beside it.

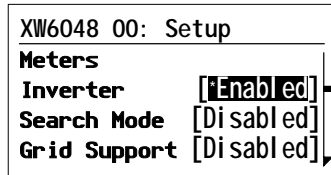

3. Press the up arrow or the down arrow button to change the value. Hold down the button to scroll through a large range of values quickly.
4. Press Enter to select the value or Exit to cancel the value selection.
5. If you have another setting to change, return to step 1.

Or

If you have no more settings to change, press Exit twice to return to the System Home screen.

Configuring the Xantrex XW System Control Panel

You can configure the Xantrex XW SCP to suit your preferences and the requirements of the Xantrex Xanbus system. Some settings, such as the system time, affect the entire system. Other settings affect only the Xantrex XW SCP, such as the brightness of the display.

You can perform all these tasks on the Xantrex XW SCP Setup menu, the Clock menu, and the System Settings menu.

Configuring the Xantrex XW SCP is done on the Xantrex XW SCP Setup menu, which you can view in either basic or advanced formats.

To view the Xantrex XW SCP Setup menu:

1. From the System Status screen, press Enter to view the Select Device menu.
2. On the Select Device menu, highlight Xantrex XW SCP and press Enter.

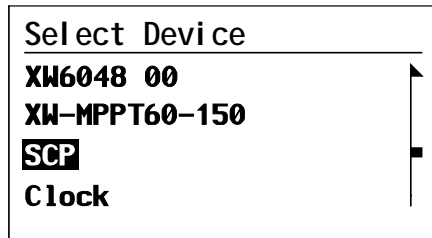

Xantrex XW SCP Configuration Items

The Xantrex XW SCP Setup menu contains settings for changing the appearance of the display, enabling button-press and alarm sounds, and setting the temperature scale. Items in gray appear only on the advanced menu.

Menu item	Menu item (translation)	Description	Values/Action	Default
Brightness		Adjusts the brightness of the display to suit interior light conditions and enhance visibility.	20% to 100% (increments of 10%)	60%
Contrast		Adjusts the contrast of the display to suit viewing angle and enhance visibility.	0% to 100% (increments of 5%)	60%
Light Timer		Sets how long the backlight remains on after the last button press on the Xantrex XW SCP.	Off, 1mins–60mins (increments of 1 minute)	2mins
Button Beep		Enables buttons to beep when pressed.	On, Off	Off
Fault Alarm		Enables an alarm to sound when a fault occurs.	On, Off	Off
LoBatt Alarm		Enables an alarm to sound when a low battery voltage condition exists.	On, Off	Off
Set Degrees		Selects the temperature scale the Xantrex XW SCP will display.	Fahrenheit, Celsius	Fahrenheit
Name		Allows you to customize the name of the Xantrex XW SCP as it is displayed on the setup menu and the Select Device menu.	Press Enter to begin customizing the name. See "Setting the Device Name" on page 3–10.	Xantrex XW SCP
Clear Faults/ Warnings		Clears active faults and warnings generated by the Xantrex XW SCP.	Press Enter to clear faults and warnings.	n/a

Menu item	Menu item (translation)	Description	Values/Action	Default
View Fault Log		Displays the Fault Log, containing the last 20 Xantrex XW SCP faults.	Press Enter to view log.	n/a
View Warning Log		Displays the Warning Log, containing the last 20 Xantrex XW SCP warnings.	Press Enter to view log.	n/a
View Event Log		Displays the Event Log, containing the last 20 Xantrex XW SCP events.	Press Enter to view log.	n/a
Restore Defaults		Restores the Xantrex XW SCP to its original factory or installer settings. After restoring defaults, please ensure the clock is set correctly.	Press Enter to restore defaults.	n/a

Setting the Device Name

The "Name" setting allows you to customize the name of the Xantrex XW SCP as it is displayed on other screens and menus.

The characters available are:

- A to Z
- a to z
- 0 to 9
- space.

Note: Increasing the number of letters in a device name may cause other text on the same line to run off the edge of the screen. Device names should be limited to 10 characters or less.

To customize the Xantrex XW SCP name:

1. Select Name on the Xantrex XW SCP Setup menu.
2. Press Enter.

The last letter of "SCP" is highlighted.

SCP: Setup	
Brightness	[70%]
Contrast	[60%]
Button Beep	[Off]
Name	[SCP] 

3. Begin customizing the device name.
 - To change the character, press the up or down arrow button. Holding down the button causes the characters to scroll more quickly.
 - To delete the character, press Exit.
 - To add characters, press Enter.
4. When the correct character is shown, press Enter to select it.
5. After pressing Enter to select the last character of your customized device name, press Enter again to return to the Setup menu.

Using the Clock Menu

Use the Clock menu to set the clock, the date, and the time format you prefer.

The clock is listed as a separate device on the Select Device menu.

Note: If a Xantrex XW Gateway is installed in your system, network time configured on the Xantrex XW Gateway overrides time configured on the Xantrex XW SCP (or any other individual device) in the network-enabled power system.

To view the Clock menu:

- ◆ On the Select Device menu, highlight Clock and press Enter.

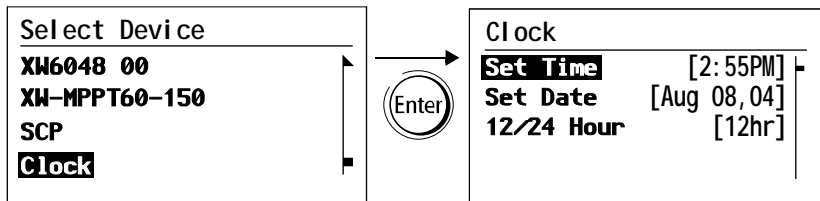

Clock Menu Configuration Items

Menu item	Menu item (translation)	Description	Values	Default
Set Time		Sets reference time for the power system.	12:00 AM–11:59 PM, 00:00–23:59	n/a
Set Date		Sets the reference date for the power system.	month day year (Jul 1, 04, for example)	n/a
12/24 Hour		Configures the Xantrex XW SCP to use a 12-hour clock or 24-hour clock.	12hr, 24hr	12hr

Setting the Time

Because the Xantrex XW SCP keeps time for the power system, setting the clock to the correct local time is essential for the system to operate as expected. The clock also provides the time stamps for the Warning and Fault logs.

When you first power up the Xantrex XW SCP, it will not begin operating normally until you set the time.

Note: The Xantrex XW SCP does not automatically adjust for Daylight Savings Time or leap year.

To set the clock:

1. On the Clock menu, with Set Time highlighted, press Enter.
The hour value is highlighted.
2. Press the up arrow or down arrow button to change the hour.
3. When the correct hour is shown, press Enter to select it and highlight the minute.
If you make an error, press Exit to move back to the value you need to reset. If you decide to abandon resetting the time, press Exit repeatedly until you return to the Clock menu.
4. Press the up arrow or down arrow button to change the minute.
5. When the correct minute is shown, press Enter to select it and highlight the AM/PM value.
If you are using a 24-hour clock, you will return to Set Time at this point. Proceed to step 8.
6. Press the up arrow or down arrow button to choose AM or PM.
7. When the correct value is shown, press Enter to select it and return to the Clock menu.
8. Press Exit to return to the Select Device menu.
If you make an error, press Exit to move back to the value you need to reset. If you decide to abandon resetting the time, press Exit repeatedly until you return to the Clock menu.

Setting the Date

You can set the reference date for the Xantrex Xanbus system from the Clock menu.

To set the date:

1. On the Clock menu, press the up arrow or down arrow button to highlight Set Date.
2. Press Enter to highlight the month.
3. Press the up arrow or down arrow button to change the month.
4. When the correct month is shown, press Enter to select it and highlight the day.

If you make an error, press Exit to move back to the value you need to reset. If you decide to abandon resetting the date, press Exit repeatedly until you return to the Clock menu.

5. Press the up arrow or down arrow button to change the day.
6. When the correct day is shown, press Enter to select it and highlight the year.
7. Press the up arrow or down arrow button to change the year.
8. When the correct year is shown, press Enter to select it and return to the Clock menu.

If you make an error, press Exit to move back to the value you need to reset. If you decide to abandon resetting the date, press Exit repeatedly until you return to the Clock menu.

Using the System Settings Menu

The System Settings menu displays information related to the operation of the entire Xantrex Xanbus system.

To view the System Settings menu:

- ◆ On the Select Device menu with System Settings highlighted, press Enter.

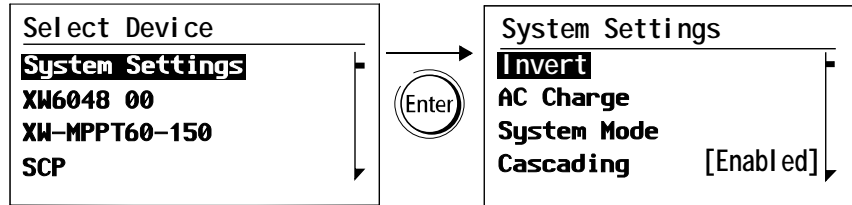

System Settings Menu Configuration Items

Menu item	Menu item (translation)	Description	Values/Action	Default
Invert		Enables or disables inverting for all inverters in the system. Press Enter to view and select values.	Enabled, Disabled	Enabled
AC Charge		Enables or disables charging on AC input for all inverter/chargers in the system. Press Enter to view and select values. This command does not affect Xantrex XW Solar Charge Controllers.	Enabled, Disabled	Enabled
System Mode		Places all the devices in the system in the selected mode. Press Enter to view and select values. See "System Modes" on page 4-2.	Operating, Standby	Operating

Menu item	Menu item (translation)	Description	Values/Action	Default
Cascading		Enables or disables cascading parameters when configuring device settings. See "Using Cascading Parameters" on page 3-17.	Enabled, Disabled	Disabled
Connection Names		Customizes the names of AC and DC connections in the system. For example, "AC1" can be changed to "Grid Power."	House Battery, Start Battery, Solar Array, Grid, Generator, AC Load	n/a
View Fault List		Displays the Fault List screen, which shows active faults in the system (up to 20). See page 4-9.	Press Enter to view list.	n/a
View Warning List		Displays the Warning List screen, which shows active warnings in the system (up to 20). See page 4-5.	Press Enter to view list.	n/a
Clear All Flts/ Wrns		Clears active faults and warnings on all devices on the system.	Press Enter to clear faults and warnings	n/a
View Device Info		Shows the model number, firmware serial number and firmware revision for each Xantrex Xanbus-enabled device.	Press Down arrow to view information for each device.	n/a

Using Cascading Parameters

Xantrex Xanbus-enabled devices are configured one at a time. However, because devices often have common settings, cascading parameters can simplify and speed up system configuration. When a parameter is “cascaded,” a newly configured device setting is applied to all devices of the same device type on a common AC or DC connection.

For example, if cascading parameters are enabled and a Battery Size (Ah) parameter is changed on the inverter/charger setup menu, the same battery size setting is applied to other inverter/chargers that share the same DC connection in the system.

To enable or disable cascading parameters:

1. On the System Settings menu, with Cascading highlighted, press Enter.
2. Use the up arrow or down arrow button to change the current setting—“Enabled” or “Disabled.”
3. Press Enter to select the new setting.

When configuring the network-managed power system with cascading parameters enabled, you should verify that the configurations have been cascaded correctly to other devices. Communication errors may cause parameters to revert to their original values or generate a warning message on the Xantrex XW SCP screen.

Viewing Device Information

The Device Info screen shows the model number, silicon chip serial number and firmware revision for each Xantrex Xanbus-enabled device. You cannot select or change any information on this screen.

To view device information:

1. On the System Settings menu, with View Device Info highlighted, press Enter.

The Device Info screen appears.

Device Info	
XW6048 01	
Model #	865-1000
Serial #	00000DB22578
F/W Rev.	1.00.00

2. Press the down arrow button to view information for each Xantrex Xanbus-enabled device on the system.
3. Press Exit to return to the System Settings menu.

4

Operation

Chapter 4 contains information and procedures for operating the Xantrex XW System Control Panel, including:

- System modes
- Faults and warnings

System Modes

The system modes described in this section affect the performance and behavior of the Xantrex XW SCP and all other Xantrex Xanbus-enabled devices. You will have to change the system mode when putting your system in storage or when installing a new Xantrex Xanbus-enabled device.

Changing System Modes

System modes are changed using the System Settings menu (see “Using the System Settings Menu” on page 3–15). The system modes are:

- Operating
- Standby.

Operating Mode

The default state of the Xantrex XW SCP is Operating mode. In Operating mode, the Xantrex XW SCP communicates with other Xantrex Xanbus-enabled devices and displays all the network information it is configured to display.

Standby Mode

While in Standby mode, the Xantrex XW SCP remains powered, “listening” and reporting its status to the network. However, the output power of all Xantrex Xanbus-enabled devices is disabled and all inverting, charging, and generator starting activity stops. Selecting Standby mode stops the generator (if it is running and a Xantrex XW Automatic Generator Start is part of the system) and puts the Xantrex XW SCP (and all Xantrex Xanbus-enabled devices) into Standby mode.

When to use

Use Standby mode when you are adding or removing devices from the network. Authorized service personnel must also put the network in Standby mode before performing software upgrades and diagnostics.

To put the power system into Standby mode:

1. On the System Settings menu, highlight “System Mode,” and press Enter.
2. Select “Standby” and press Enter.

To return to Operating mode:

1. On the System Settings menu, highlight "System Mode," and press Enter.
2. Select "Operating" and press Enter.

Using the Standby Button

Pressing the Standby Button produces the same result as disabling "Invert" and "AC Charge" from the System Settings menu on the Xantrex XW SCP. Pressing the Standby button does not affect Charge Controller operation. After disabling inverting and charging with the Standby button, the system continues to pass AC input through to the loads.

Pressing the Exit and Standby buttons at the same time puts the entire Xantrex XW power system (including Charge Controllers) into standby mode. In standby mode, the Xantrex XW inverter/chargers stop passing AC input through to the loads, and "Stb" is displayed on Inverter Information Panel.

After the keypress command to enter standby mode, the Xantrex XW AGS (if installed) shuts down the generator (if it is running) after a cool-down cycle.

Warnings and Faults

This section describes how fault and warning messages behave, and what you should do when they appear. For a complete list of fault and warning messages specific to the Xantrex XW SCP, along with recommended actions to correct the fault or warning condition, refer to Chapter 5, "Troubleshooting".

Important: The Xantrex XW SCP displays fault and warning messages for all Xantrex Xanbus-enabled devices in the system. For information about fault and warnings for other devices, refer to the Troubleshooting chapter in the Owner's Guide or Operation Guide for each device.

Warning Messages

Warning messages appear when the Xantrex XW SCP detects a condition that may eventually affect its continued operation. When a warning occurs, the Xantrex XW SCP continues operating. However, you should consult the Troubleshooting chapter to find out what actions you can take to prevent the warning from escalating into a fault.

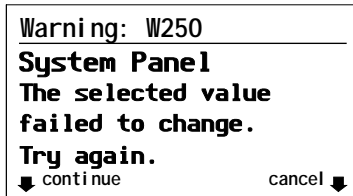

Figure 4-1 Xantrex XW SCP Warning Message

Types

There are two types of warning messages: manual and automatic. Each differs in its behavior and appearance. For a list of Xantrex XW SCP warnings and their associated types, refer to Chapter 5, "Troubleshooting".

If you see a warning message on the Xantrex XW SCP, you will have to acknowledge it and (if necessary) clear it. Acknowledging the warning allows you to continue operating the Xantrex XW SCP. Clearing the warning message stops the warning condition from escalating into a fault.

Acknowledging Warning Messages

Automatic warnings

Acknowledging an automatic warning message removes the message from the Xantrex XW SCP screen.

To acknowledge an automatic warning message, press Enter. After you acknowledge the warning, the Xantrex XW SCP displays the menu for the device that caused the warning.

The Xantrex XW SCP removes an unacknowledged automatic warning message from the screen after three minutes. However, if the condition that caused the warning still exists, the warning message will reappear.

You can view a list of the last 20 warning messages from the Xantrex XW SCP on the Warning log. See "Viewing the Xantrex XW SCP Warning Log" on page 4-6.

Manual warnings

A manual warning message requires you to make a choice (usually by pressing Enter for “yes” or Exit for “no”) before you can proceed monitoring or configuring the Xantrex XW SCP. It will not disappear after three minutes. After you respond to the warning message the Xantrex XW SCP clears the warning message and returns to the screen it was displaying before the warning message appeared.

Clearing Warning Messages

Automatic warning messages clear when the warning condition on the Xantrex XW SCP disappears or when the criteria for clearing the warning are met.

You can clear a manual warning message by pressing Enter or Exit in response to the message.

Viewing Multiple Warning Messages

If several warning messages occur before you can acknowledge or clear them, they are displayed together on a warning list. The warning list contains messages from every Xantrex Xanbus-enabled device, not just the Xantrex XW SCP. You can select a message from the warning list and view its details.

To view a message from the warning list:

1. On the warning list, use the up arrow or down arrow button to highlight the warning message you want to view.
2. Press Enter.

The complete warning message appears.

After viewing the warning message, you can return to the warning list by pressing Exit or continue to the menu for the device that caused the warning by pressing Enter. Each time you return to the warning list after viewing a complete message, the viewed message is removed from the list.

If you have left the warning list, you can view it at any time from the System Settings menu.

To view the warning list:

1. On the Select Device menu, highlight System Settings and press Enter.
2. On the System Settings menu, highlight View Warning List and press Enter.

Viewing the Xantrex XW SCP Warning Log

The Xantrex XW SCP warning log displays the 20 most recent warnings that the Xantrex XW SCP generated. These warnings can be both active and cleared. Each warning in the log is identified by a warning code and the time that it occurred. You may need to refer to the warning log before consulting Chapter 5, "Troubleshooting", or before you call technical support.

To view the warning log:

1. On the Xantrex XW SCP menu, press the down arrow button to highlight View Warning Log.
2. Press Enter.

To return to the Xantrex XW SCP menu:

- ◆ From the Warning log, press Exit.

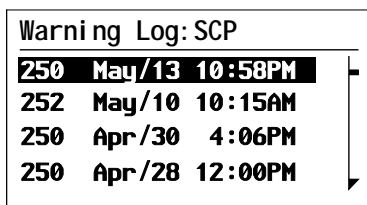

Figure 4-2 Xantrex XW SCP Warning Log

Viewing Individual Warning Messages from the Warning Log

On the warning log, you can also select an individual warning and view its details.

To view details for a warning:

1. Use the up arrow or down arrow button to highlight the warning message you want to view.
2. Press Enter.

The complete message appears.

To return to the warning log:

- ◆ Press Exit (as indicated by the arrow marked "cancel").

To proceed to the device menu and adjust device settings to eliminate the warning condition:

- ◆ Press Enter (as indicated by the arrow marked "continue").

Fault Messages

Fault messages appear when the Xantrex XW SCP's operation is affected by a condition that requires immediate attention. When a fault occurs, the Xantrex XW SCP stops operating until either the fault condition goes away or until you manually clear the fault and take action to eliminate the fault condition.

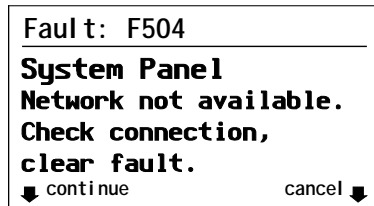

Figure 4-3 Xantrex XW SCP Fault Message

Types of fault messages

There are two types of Xantrex XW SCP fault messages: automatic and manual. For a list of faults and their associated types, refer to Chapter 5.

Automatic faults clear themselves automatically if the fault condition goes away.

Manual faults require you to clear them by:

- Selecting Clear Faults/Warnings on the menu of the device that generated the fault (if the fault condition still exists, the fault message will reappear).
- Correcting the condition that caused the fault.

Viewing the Xantrex XW SCP Fault Log

The fault log lists the most recent Xantrex XW SCP faults, up to a total of 20. On each line, the log shows the fault code, the date the fault occurred, and the time the fault occurred.

Fault Log: SCP		
252	Apr/5	10:58PM
252	Apr/5	10:15AM
252	Mar/30	4:06PM
250	Jan/1	12:00PM

Figure 4-4 Xantrex XW SCP Fault Log

To view the fault log:

1. On the Xantrex XW SCP advanced menu, press the down arrow button to highlight Fault log.
2. Press Enter.

To return to the Xantrex XW SCP menu:

- ◆ Press Exit.

Viewing Individual Fault Messages from the Fault Log

On the fault log, you can also select an individual fault and view its details.

To view details for a fault:

1. Use the up arrow or down arrow button to highlight the fault message you want to view.
2. Press Enter.
The complete fault message appears.

To return to the fault log:

- ◆ Press Exit (as indicated by the arrow marked "cancel").

To proceed to the device menu and reconfigure the device to eliminate the fault condition:

- ◆ Press Enter (as indicated by the arrow marked "continue").

On the device menu, you can also attempt to clear the fault by selecting Clear Faults/Warnings.

Viewing Multiple Fault Messages

If several faults occur before you can acknowledge or clear them, the Xantrex XW SCP displays the accumulated messages on a fault list. The fault list displays messages from all network-enabled devices, not just the Xantrex XW SCP. You can select a message and view complete information for it from the fault list.

To view a message from the fault list:

1. On the fault list, use the up arrow or down arrow button to highlight the fault message you want to view.
2. Press Enter.
The complete fault message appears.
3. To return to the fault list, press Exit.
Or
To return to the Xantrex XW SCP menu, press Enter.

Each time you return to the fault list after viewing a complete message, the message you viewed is removed from the list.

You can also view the fault list at any time.

To view the fault list at any time:

1. On the Select Device menu, use the up arrow or down arrow button to highlight System Settings.
2. Press Enter.
3. On the System Settings menu, use the down arrow button to highlight View Fault List.
4. Press Enter.

5

Troubleshooting

Chapter 5 contains reference tables of warning and fault messages that relate to the Xantrex XW SCP. For information about warning and fault messages that relate another device, see the guide for that device.

Use these tables to help you identify the cause of the fault or warning, and determine the best course of action to correct the condition that caused the fault or warning.

Troubleshooting Reference

Types of Faults and Warnings

The various types of fault and warning messages behave differently, and give you the option to treat them differently when they appear. For more information about the types of fault and warning messages, see “Types” on page 4-4 and “Types of fault messages” on page 4-7.

Warning Reference Table

Table 5-1 Warning Reference Table

Warning number	Message	Message (translation)	Type	Cause	Action
W250	The value failed to change. Try again.		Automatic	<p>A Xantrex Xanbus-enabled device rejected the new setting.</p> <p>A temporary communication problem stopped the Xantrex XW SCP changing a value that you entered.</p>	<p>Check device operation guide and settings. The setting may be out of range, the system mode may be incorrect, or another device setting is overriding the setting you want to change.</p> <p>Try changing the value again.</p>

Table 5-1 Warning Reference Table

Warning number	Message	Message (translation)	Type	Cause	Action
W251	Please confirm: Equalization process.		Manual	You have enabled Equalization on the inverter/ charger or charge controller menu.	Press Enter to begin equalizing batteries or Exit to return to the previous menu.
W252	Please confirm: Restore default settings.		Manual	You have selected the Restore Defaults command.	Press Enter to restore default settings or Exit to cancel.
W254	The value failed to change. Try again.		Manual	The setting you are changing can only be changed when the system is in Standby mode.	Put the system in Standby mode, change the setting, then return the system to Operating mode.
W255	System clock not set. Set correct time.		Manual	On initial startup, the clock needs to be set. The system will not operate correctly until it is.	Set the clock to the correct time. See "Using the Clock Menu" on page 3-12.
W256	A device is lost. Check connection.		Manual	The Xantrex XW SCP has lost communications with another device on the network.	Check network connection between the Xantrex XW SCP and the device.
W257	New device detected. Check device settings.		Manual	You have connected a new device to the network or reconnected a disconnected device.	Acknowledge the message and check that the device is properly configured.

Table 5-1 Warning Reference Table

Warning number	Message	Message (translation)	Type	Cause	Action
W258	Device instance is duplicated.		Manual	Two networked devices of the same type have the same instance.	Select a different instance ID on one of the devices' Setup menu.
W501	SCP has fixed a memory problem, restored defaults.		Manual	The Xantrex XW SCP encountered an internal memory problem upon startup. To remain operational, the Xantrex XW SCP restored its default settings.	Acknowledge the warning and reset configurable settings if necessary.
W502	Not reporting; Info may be missing.		Manual		

Fault Reference Table

Table 5-2 Fault Reference Table

Fault number	Message	Message (translation)	Type	Cause	Action
F250	System clock not set. Set correct time.		Manual	On initial startup, the clock needs to be set. The system will not operate correctly until it is.	Set the clock to the correct time. See "Using the Clock Menu" on page 3-12.
F251	A device is lost. Check connection.		Manual	The Xantrex XW SCP has lost communications with another device on the network.	Check network connection between the Xantrex XW SCP and the device.
F252	New device detected. Check device settings.		Manual	You have connected a new device to the network or reconnected a disconnected device.	Acknowledge the message and check that the device is properly configured.
F500	Internal failure. Service required.		Manual	The silicon serial ID number has failed and the Xantrex XW SCP has gone into Standby mode.	Reset the Xantrex XW SCP by removing and restoring network power. If problem persists, call customer service.
F501	Memory failure. Service required.		Manual	The Xantrex XW SCP has suffered a non-volatile memory failure.	Reset the Xantrex XW SCP by removing and restoring network power. If problem persists, call customer service.

Table 5-2 Fault Reference Table

Fault number	Message	Message (translation)	Type	Cause	Action
F503	Internal reset. Call customer support.		Manual	The real-time clock in the Xantrex XW SCP has failed.	Reset the Xantrex XW SCP by removing and restoring network power. If problem persists, call customer service.
F504	Lost network connection.		Automatic	The Xantrex XW SCP has lost communications with the network because of a faulty connection or electronic signal disruption.	Check connection between the Xantrex XW SCP and the network.
F505	Internal failure. See guide.		Manual	A controller fault has occurred and the Xantrex XW SCP has gone into Standby mode.	Reset the Xantrex XW SCP by removing and restoring network power. If problem persists, disconnect and reconnect network cables.

A

Specifications

Appendix A contains the electrical and physical specifications for the Xantrex XW System Control Panel.

All specifications are subject to change without notice.

Electrical Specifications

Nominal input network voltage	15 Vdc
Minimum operating network voltage	14.25 Vdc
Maximum operating network voltage	15.75 Vdc
Maximum operating current	200 mA @ nominal input network voltage
Communication physical layer	2, CAN
Communication protocol	Xantrex Xanbus
Maximum cable length	40 m (130 ft)
Connectors	2 RJ-45—8 pins
Display	Dot matrix 128 × 64 LCD with white LED backlight

Mechanical Specifications

Dimensions (W × H × D)	152 × 103 × 40 mm ($6 \times 4 \times 1 \frac{9}{16}$ ")
Shipping dimensions	267 × 210 × 63 mm ($10\frac{1}{2} \times 8 \frac{1}{4} \times 2 \frac{1}{2}$ ")
Weight	208 g (0.46 lb)
Shipping weight	780 g (1.72 lb)

Regulatory Compliance

Safety	CSA certified to CSA 107.1-01 and UL 458 4th Ed. including the marine supplement
EMC	FCC Part 15B Class B Industry Canada ICES-0003 Class B
CE marked under the EMC Directive 2004/108/EC	Complies with the following: EN61000-6-1:2007 Generic standards - Immunity for residential, commercial and light industrial environments EN61000-6-3:2007 Generic standards - Emissions for residential, commercial and light industrial environments

Environmental Specifications

Operating temperature	-20 to 50 °C (-4 to 122 °F)
Storage temperature	-40 to 85 °C (-40 to 185 °F)
Maximum case temperature	60 °C (140 °F)
Operating humidity	5% to 95%
Storage humidity	5% to 95%

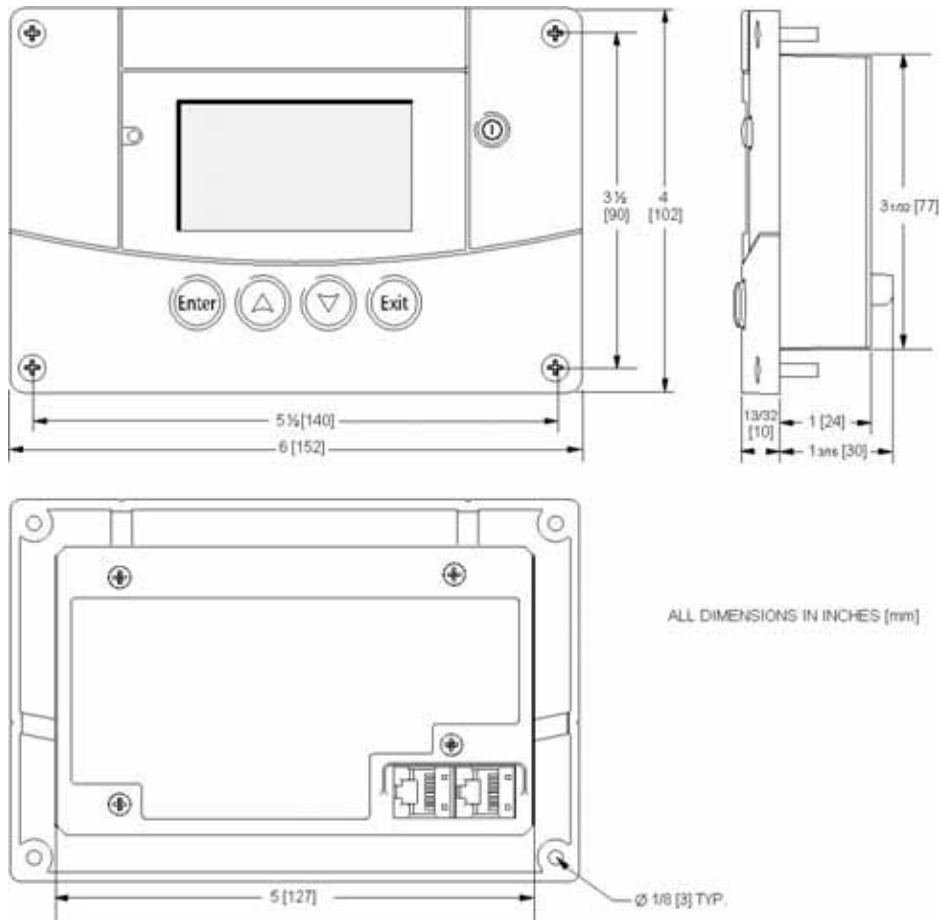

Figure A-1 Xantrex XW SCP Dimensions

Warranty and Return Information

Warranty

What does this warranty cover and how long does it last? This Limited Warranty is provided by Xantrex Technology Inc. ("Xantrex") and covers defects in workmanship and materials in your Xantrex XW System Control Panel. This warranty period lasts for 5 years from the date of purchase at the point of sale to you, the original end user customer, unless otherwise agreed in writing (the "Warranty Period"). You will be required to demonstrate proof of purchase to make warranty claims.

This Limited Warranty is transferable to subsequent owners but only for the unexpired portion of the Warranty Period. Subsequent owners also require original proof of purchase as described in "What proof of purchase is required?"



What will Xantrex do? During the Warranty Period Xantrex will, at its option, repair the product (if economically feasible) or replace the defective product free of charge, provided that you notify Xantrex of the product defect within the Warranty Period, and provided that Xantrex through inspection establishes the existence of such a defect and that it is covered by this Limited Warranty.

Xantrex will, at its option, use new and/or reconditioned parts in performing warranty repair and building replacement products. Xantrex reserves the right to use parts or products of original or improved design in the repair or replacement. If Xantrex repairs or replaces a product, its warranty continues for the remaining portion of the original Warranty Period or 90 days from the date of the return shipment to the customer, whichever is greater. All replaced products and all parts removed from repaired products become the property of Xantrex.

Xantrex covers both parts and labor necessary to repair the product, and return shipment to the customer via a Xantrex-selected non-expedited surface freight within the contiguous United States and Canada. Alaska, Hawaii and outside of the United States and Canada are excluded. Contact Xantrex Customer Service for details on freight policy for return shipments from excluded areas.

How do you get service? If your product requires troubleshooting or warranty service, contact your merchant. If you are unable to contact your merchant, or the merchant is unable to provide service, contact Xantrex directly at:

www.schneider-electric.com

			
North America	1 650 351 8237 1 866 519 1470	1 925 245 1022	re.techsupport@schneider-electric.com
La France	+0825012999		fr-re-techsupport@fr.schneider-electric.com
Deutschland	+49 (0) 180 575 6575	+49 (0) 2102 404 7101	solarservice@de.schneider-electric.com
España	+34 93 498 7466	+34 93 305 5026	re.techsupport@es.schneider-electric.com
L'Italia	+39 035 4151111	+39 035415 3200	IT-pronto-contatto@it.schneider-electric.com

For other country details please contact your local Schneider Electric Sales Representative or visit our website at: <http://www.schneider-electric.com/sites/corporate/en/support/operations/local-operations/local-operations.page>

Direct returns may be performed according to the Xantrex Return Material Authorization Policy described in your product manual. For some products, Xantrex maintains a network of regional Authorized Service Centers. Call Xantrex or check our website to see if your product can be repaired at one of these facilities.

What proof of purchase is required? In any warranty claim, dated proof of purchase must accompany the product and the product must not have been disassembled or modified without prior written authorization by Xantrex.

Proof of purchase may be in any one of the following forms:

- The dated purchase receipt from the original purchase of the product at point of sale to the end user; or
- The dated dealer invoice or purchase receipt showing original equipment manufacturer (OEM) status; or
- The dated invoice or purchase receipt showing the product exchanged under warranty.

What does this warranty not cover? Claims are limited to repair and replacement, or if in Xantrex's discretion that is not possible, reimbursement up to the purchase price paid for the product. Xantrex will be liable to you only for direct damages suffered by you and only up to a maximum amount equal to the purchase price of the product.

This Limited Warranty does not warrant uninterrupted or error-free operation of the product or cover normal wear and tear of the product or costs related to the removal, installation, or troubleshooting of the customer's electrical systems. This warranty does not apply to and Xantrex will not be responsible for any defect in or damage to:

- a) the product if it has been misused, neglected, improperly installed, physically damaged or altered, either internally or externally, or damaged from improper use or use in an unsuitable environment;
- b) the product if it has been subjected to fire, water, generalized corrosion, biological infestations, or input voltage that creates operating conditions beyond the maximum or minimum limits listed in the Xantrex product specifications including, but not limited to, high input voltage from generators and lightning strikes;
- c) the product if repairs have been done to it other than by Xantrex or its authorized service centers (hereafter "ASCs");
- d) the product if it is used as a component part of a product expressly warranted by another manufacturer;
- e) component parts or monitoring systems supplied by you or purchased by Xantrex at your direction for incorporation into the product;
- f) the product if its original identification (trade-mark, serial number) markings have been defaced, altered, or removed;
- g) the product if it is located outside of the country where it was purchased; and
- h) any consequential losses that are attributable to the product losing power whether by product malfunction, installation error or misuse.

Disclaimer

Product

THIS LIMITED WARRANTY IS THE SOLE AND EXCLUSIVE WARRANTY PROVIDED BY XANTREX IN CONNECTION WITH YOUR XANTREX PRODUCT AND IS, WHERE PERMITTED BY LAW, IN LIEU OF ALL OTHER WARRANTIES, CONDITIONS, GUARANTEES, REPRESENTATIONS, OBLIGATIONS AND LIABILITIES, EXPRESS OR IMPLIED, STATUTORY OR OTHERWISE IN CONNECTION WITH THE PRODUCT, HOWEVER ARISING (WHETHER BY CONTRACT, TORT, NEGLIGENCE, PRINCIPLES OF MANUFACTURER'S LIABILITY, OPERATION OF LAW, CONDUCT, STATEMENT OR OTHERWISE), INCLUDING WITHOUT RESTRICTION ANY IMPLIED WARRANTY OR CONDITION OF QUALITY, MERCHANTABILITY OR FITNESS FOR A PARTICULAR PURPOSE. ANY IMPLIED WARRANTY OF MERCHANTABILITY OR FITNESS FOR A PARTICULAR PURPOSE TO THE EXTENT REQUIRED UNDER APPLICABLE LAW TO APPLY TO THE PRODUCT SHALL BE LIMITED IN DURATION TO THE PERIOD STIPULATED UNDER THIS LIMITED WARRANTY.

IN NO EVENT WILL XANTREX BE LIABLE FOR: (A) ANY SPECIAL, INDIRECT, INCIDENTAL OR CONSEQUENTIAL DAMAGES, INCLUDING LOST PROFITS, LOST REVENUES, FAILURE TO REALIZE EXPECTED SAVINGS, OR OTHER COMMERCIAL OR ECONOMIC LOSSES OF ANY KIND, EVEN IF XANTREX HAS BEEN ADVISED, OR HAD REASON TO KNOW, OF THE POSSIBILITY OF SUCH DAMAGE; (B) ANY LIABILITY ARISING IN TORT, WHETHER OR NOT ARISING OUT OF XANTREX'S NEGLIGENCE, AND ALL LOSSES OR DAMAGES TO ANY PROPERTY OR FOR ANY PERSONAL INJURY OR ECONOMIC LOSS OR DAMAGE CAUSED BY THE CONNECTION OF A PRODUCT TO ANY OTHER DEVICE OR SYSTEM; AND (C) ANY DAMAGE OR INJURY ARISING FROM OR AS A RESULT OF MISUSE OR ABUSE, OR THE INCORRECT INSTALLATION, INTEGRATION OR OPERATION OF THE PRODUCT BY PERSONS NOT AUTHORIZED BY XANTREX.

Exclusions

If this product is a consumer product, federal law does not allow an exclusion of implied warranties. To the extent you are entitled to implied warranties under federal law, to the extent permitted by applicable law they are limited to the duration of this Limited Warranty. Some states, provinces and jurisdictions do not allow limitations or exclusions on implied warranties or on the duration of an implied warranty or on the limitation or exclusion of incidental or consequential damages, so the above limitation(s) or exclusion(s) may not apply to you. This Limited Warranty gives you specific legal rights. You may have other rights which may vary from state to state, province to province or jurisdiction to jurisdiction.

Return Material Authorization Policy

For those products that are not being repaired in the field and are being returned to Xantrex, before returning a product directly to Xantrex you must obtain a Return Material Authorization (RMA) number and the correct factory "Ship To" address. Products must also be shipped prepaid. Product shipments will be refused and returned at your expense if they are unauthorized, returned without an RMA number clearly marked on the outside of the shipping box, if they are shipped collect, or if they are shipped to the wrong location.

When you contact Xantrex to obtain service, please have your instruction manual ready for reference and be prepared to supply:

- The serial number of your product
- Information about the installation and use of the unit
- Information about the failure and/or reason for the return
- A copy of your dated proof of purchase

Record these details in "Information About Your System".

Return Procedure

Package the unit safely, preferably using the original box and packing materials. Please ensure that your product is shipped fully insured in the original packaging or equivalent. This warranty will not apply where the product is damaged due to improper packaging.

Include the following:

- The RMA number supplied by Xantrex Technology Inc. clearly marked on the outside of the box.
- A return address where the unit can be shipped. Post office boxes are not acceptable.
- A contact telephone number where you can be reached during work hours.
- A brief description of the problem.

Ship the unit prepaid to the address provided by your Xantrex customer service representative.

If you are returning a product from outside of the USA or Canada In addition to the above, you MUST include return freight funds and are fully responsible for all documents, duties, tariffs, and deposits.

If you are returning a product to a Xantrex Authorized Service Center (ASC) A Xantrex return material authorization (RMA) number is not required. However, you must contact the ASC prior to returning the product or presenting the unit to verify any return procedures that may apply to that particular facility and that the ASC repairs this particular Xantrex product.

Out of Warranty Service

If the warranty period for your product has expired, if the unit was damaged by misuse or incorrect installation, if other conditions of the warranty have not been met, or if no dated proof of purchase is available, your unit may be serviced or replaced for a flat fee.

To return your product for out of warranty service, contact Xantrex Customer Service for a Return Material Authorization (RMA) number and follow the other steps outlined in "Return Procedure".

Payment options such as credit card or money order will be explained by the Customer Service Representative. In cases where the minimum flat fee does not apply, as with incomplete units or units with excessive damage, an additional fee will be charged. If applicable, you will be contacted by Customer Service once your unit has been received.

Information About Your System

As soon as you open your Xantrex XW System Control Panel package, record the following information and be sure to keep your proof of purchase.

- Serial Number _____
- Product Number 865-1050
- Purchased From _____
- Purchase Date _____

If you need to contact Customer Service, please record the following details before calling. This information will help our representatives give you better service.

- Other Xantrex XW Equipment installed
 - Xantrex XW Inverter/Charger Model: _____ Firmware Rev: _____
 - Xantrex XW Solar Charge Controller Model: _____ Firmware Rev: _____
 - Xantrex XW System Control Panel Firmware Rev: _____
 - Length of time Xantrex XW SCP has been installed _____
 - Battery/battery bank size _____
 - Generator brand/type _____
 - DC wiring size and length _____
 - Alarm sounding? _____
 - Description of indicators on front panel _____
 - Appliances operating when problem occurred _____
 - Warning or Fault message _____
 - Description of problem _____
- _____
- _____

Index

Numerics

12/24 Hour 3–12

A

Advanced menu 3–7

B

backlight timer 3–9

brightness 3–9

Button Beep 3–9

C

changing device settings 3–6

Clear Faults 3–9

Clock menu 3–12

configuration

any network-enabled device 3–2

contrast 3–9

Customer Service

preparing to call WA–4

D

date, setting 3–14

device info 3–16

Device Information 3–17

Down arrow button 1–3, 3–2

E

electrical specifications A–2

Enter button 1–3, 3–2

environmental specifications A–3

Exit button 1–3, 3–2

F

Fault alarm 3–9

fault light 1–3

Fault list 3–16, 4–9

Fault log 3–10, 4–8

fault messages

clearing 3–9

types 4–7

fault reference table 5–5

firmware revision 3–17

I

Information about Your System form WA–4

installation

connecting network cables 2–9

mounting 2–7, 2–10

planning 2–2

inverter

purchase date WA–4

serial number WA–4

K

keypress for system standby mode 4–3

L

Light Timer 3–9

LoBatt Alarm 3–9

M

mechanical specifications A–2

Mode 3–15

mounting template 2–10

N

- navigation
 - using buttons 3-2
- network cables 2-9
- Network diagram 1-4
- network power consumption 1-2

O

- Operating mode 4-2

P

- proof of purchase WA-4
- purchase date WA-4

S

- Schneider Electric
 - Website v
- SCP
 - device menu 3-5
 - select device menu 3-5
- serial number WA-4
- Set Date 3-12
- Set Degrees 3-9
- Set Time 3-12
- specifications A-2
- standby button 1-3, 4-3
- Standby mode 4-2
- startup screen 3-3
- system home screen 3-4
- system modes 4-2
- system standby mode 4-3

T

- time, format and setting 3-13

U

- Up arrow button 1-3, 3-2

V

- verifying network power 2-11
- view device info 3-16
- View Fault Log 3-10
- View Warning Log 3-10

W





- Warning list 3-16
- Warning log 3-10, 4-6
- warning messages 4-4
- warning reference table 5-2

X

- Xanbus 1-2

Schneider Electric

www.schneider-electric.com

			
North America	1 650 351 8237 1 866 519 1470	1 925 245 1022	re.techsupport@schneider-electric.com
La France	+0825012999		fr-re-techsupport@fr.schneider-electric.com
Deutschland	+49 (0) 180 575 6575	+49 (0) 2102 404 7101	solarservice@de.schneider-electric.com
España	+34 93 498 7466	+34 93 305 5026	re.techsupport@es.schneider-electric.com
L'Italia	+39 035 4151111	+39 035415 3200	IT-pronto-contatto@it.schneider-electric.com

For other country details please contact your local Schneider Electric Sales Representative or visit our website at: <http://www.schneider-electric.com/sites/corporate/en/support/operations/local-operations/local-operations.page>